

Shortlist Masterplan Wind

Effect of piling noise on the survival of fish larvae (pilot study)

L.J. Bolle¹, C.A.F. de Jong², S. Bierman¹, D. de Haan¹,
T. Huijer¹, D. Kaptein², M. Lohman¹, S. Tribuhl¹,
P. van Beek², C. J.G. van Damme¹, F. van den Berg²,
J. van der Heul¹, O. van Keeken¹, P. Wessels²,
E. Winter¹

¹ IMARES ² TNO

Report number CO92/11

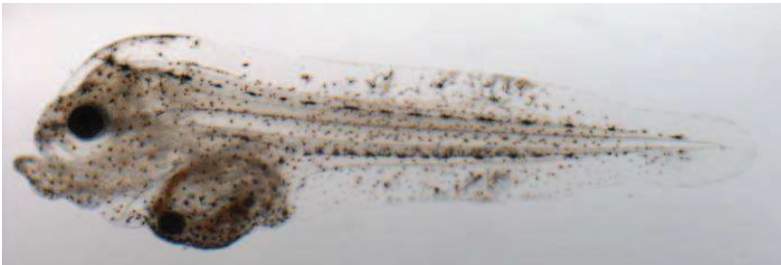

IMARES Wageningen UR

(IMARES - Institute for Marine Resources & Ecosystem Studies)

Client:

Rijkswaterstaat Waterdienst
Postbus 17
8200 AA Lelystad

Publication date:

23 June 2011

IMARES is:

- an independent, objective and authoritative institute that provides knowledge necessary for an integrated sustainable protection, exploitation and spatial use of the sea and coastal zones;
- an institute that provides knowledge necessary for an integrated sustainable protection, exploitation and spatial use of the sea and coastal zones;
- a key, proactive player in national and international marine networks (including ICES and EFARO).

P.O. Box 68
1970 AB IJmuiden
Phone: +31 (0)317 48 09 00
Fax: +31 (0)317 48 73 26
E-Mail: imares@wur.nl
www.imares.wur.nl

P.O. Box 77
4400 AB Yerseke
Phone: +31 (0)317 48 09 00
Fax: +31 (0)317 48 73 59
E-Mail: imares@wur.nl
www.imares.wur.nl

P.O. Box 57
1780 AB Den Helder
Phone: +31 (0)317 48 09 00
Fax: +31 (0)223 63 06 87
E-Mail: imares@wur.nl
www.imares.wur.nl

P.O. Box 167
1790 AD Den Burg Texel
Phone: +31 (0)317 48 09 00
Fax: +31 (0)317 48 73 62
E-Mail: imares@wur.nl
www.imares.wur.nl

© 2011 IMARES Wageningen UR

IMARES, institute of Stichting DLO is registered in the Dutch trade record nr. 09098104, BTW nr. NL 806511618

The Management of IMARES is not responsible for resulting damage, as well as for damage resulting from the application of results or research obtained by IMARES, its clients or any claims related to the application of information found within its research. This report has been made on the request of the client and is wholly the client's property. This report may not be reproduced and/or published partially or in its entirety without the express written consent of the client.

A_4_3_2-V12

Contents

Summary.....	5
Nederlandse samenvatting	6
1. Introduction	7
1.1 General introduction.....	7
1.2 Management background	7
1.3 Assignment and boundaries.....	8
1.4 Reading guide	8
2. Materials and Methods	9
2.1 Experimental set-up	9
2.2 Fish larvae	18
2.3 Initial series of experiments	22
2.4 Power analysis.....	24
2.5 Second series of experiments	26
2.6 Statistical analysis	27
3. Results.....	28
3.1 Sound measurements.....	28
3.2 Initial series of experiments	29
3.3 Second series of experiments	33
4. Discussion	37
4.1 General discussion	37
4.2 Management implications.....	39
4.3 Future research	40
5. Quality Assurance	43
References.....	44
Justification.....	48
Appendix A. TNO memo 1	49
Appendix B. TNO memo 2	62
Appendix C. TNO memo 3	73

Appendix D. TNO memo 4	84
Appendix E. TNO memo 5.....	89
Appendix F. TNO memo 6.....	100
Appendix G. IMARES memo 1	114
Appendix H. IMARES memo 2	123
Appendix I. IMARES memo 3	130

Summary

Fish can suffer lethal damage to their swim bladder or other organs due to loud impulse sounds such as pile driving noise. However, detailed dose-response studies are still scarce, especially for the early life stages. In view of the rapid extension of offshore wind farms in the North Sea, there is an urgent need to acquire more knowledge on the effects of noise caused by pile driving. This study focussed on the effect of piling noise on the survival of fish larvae.

The first goal of this study, to develop a laboratory set-up in which impulse sounds representative of pile driving noise can be generated, was achieved successfully. The device consists of a rigid-walled cylindrical chamber (110 mm diameter, 160 mm high), driven by an electro dynamical sound projector. Samples of up to 100 larvae can be exposed simultaneously to a homogeneously distributed sound pressure and particle velocity field, at a controllable static pressure up to 3 bar. Two configurations are available with either a dominant sound pressure or a dominant particle velocity exposure. Recorded piling noise can be reproduced in a controlled way, in the frequency range between 50 and 1000 Hz, at peak pressure levels up to 212 dB re 1 μPa^2 and single pulse Sound Exposure Levels up to 187 dB re 1 $\mu\text{Pa}^2\text{s}$, or peak particle velocity levels up to 147 dB re 1 $(\text{nm/s})^2$ and particle velocity exposure levels up to 124 dB re 1 $(\text{nm/s})^2\text{s}$.

The laboratory set-up was used in a pilot study, which aimed at determining the sound threshold for larval mortality. The study was limited to lethal effects on the larvae of one fish species: common sole (*Solea solea*). Experiments were carried in which different developmental stages were exposed to various levels and durations of piling noise. The initial series of experiments indicated that an effect of sound pressure exposure may occur, but the differences were not statistically significant, possibly due to sample size. The results were used for a power analysis to determine the batch size and number of replicates required in next experiments. The project was elaborated with a second series of experiments, which consisted of three treatments: two sound pressure exposures and one control group. Each treatment was repeated 15 times (with 25 larvae per batch), for each of three larval stages. The highest exposure level (cumulative SEL=206 dB re 1 $\mu\text{Pa}^2\text{s}$) represented 100 pulses at a distance of 100 m from a 'typical' North Sea piling site. No significant effects were observed in any of the three larval stages.

The fact that we didn't find significant effects at a cumulative SEL of 206 dB was remarkable, given the US interim criterion for non-auditory tissue damage in fish <2 gram at a cumulative SEL of 183 dB. Also, the assumption of 100% mortality within a radius of 1000 m around a piling site used in the Appropriate Assessment of Dutch offshore wind farms, appears to be too conservative in the case of common sole larvae. The results of this study cannot be extrapolated to fish larvae in general, as interspecific differences in vulnerability to sound exposure may occur. However, this study does indicate that the previous assumptions and criteria may need to be revised.

Nederlandse samenvatting

Vissen kunnen letale schade ondervinden aan de zwemblaas of andere organen door blootstelling aan harde impulsgeluiden zoals onderwater heigeluid. Er zijn echter nog vrijwel geen gedetailleerde dosis-respons studies beschikbaar, dit geldt m.n. voor de vroege levensstadia. Gezien de snelle uitbreiding van offshore windparken in de Noordzee, bestaat er een dringende noodzaak om meer kennis te verwerven over de effecten van het geluid veroorzaakt door heien. Deze studie richt zich op het effect van heigeluid op de overleving van vislarven.

Het eerste doel van het project was het ontwikkelen van een laboratorium opstelling waarin impulsgeluiden kunnen worden gegenereerd die representatief zijn voor heigeluid. Hierin zijn we geslaagd. Het ontwikkelde apparaat bestaat uit een rigide cilindrische kamer (110 mm diameter, 160 mm hoog) die wordt aangedreven door een elektro-dynamische geluidsbron. Tot 100 larven kunnen gelijktijdig blootgesteld worden aan een homogeen verdeeld geluidsdruk- en deeltjessnelheidsveld, bij een statische druk tot 3 bar. Er zijn twee configuraties mogelijk; een dominante geluidsdruk- of een dominante deeltjessnelheidsblootstelling. Opgenomen heigeluid kan worden gereproduceerd op een gecontroleerde wijze, in het frequentiegebied tussen 50 Hz en 1000 Hz, bij een piek geluidsdruk tot 212 dB re 1 μPa^2 en een enkele puls geluidsdrukblootstellingsniveau tot 187 dB re 1 $\mu\text{Pa}^2\text{s}$, of bij een piek deeltjessnelheid tot 147 dB re 1 $(\text{nm/s})^2$ en een deeltjessnelheidsblootstellingsniveau tot 124 dB re 1 $(\text{nm/s})^2\text{s}$.

De laboratoriumopstelling werd gebruikt in een pilot studie met als doel het bepalen van de geluidsdrempel voor larvale mortaliteit. De studie was beperkt tot letale effecten op de larven van één vissoort: tong (*Solea solea*). Er werden experimenten uitgevoerd waarin verschillende ontwikkelingsstadia blootgesteld werden aan verschillende niveaus en duur van heigeluid. In de eerste reeks experimenten leek een effect van geluidsdrukblootstelling op te treden, maar de verschillen waren niet statistisch significant, mogelijk als gevolg van steekproefgroottes. Om de batch grootte en het aantal herhalingen dat nodig was in vervollexperimenten te kunnen bepalen zijn de eerste resultaten gebruikt voor een power analyse. Het project werd uitgebreid met een tweede reeks experimenten die bestond uit drie behandelingen: twee geluidsdrukblootstellingen en één controlegroep. Elke behandeling werd 15 keer herhaald (met 25 larven per batch), voor elk van de drie larvale stadia. Het hoogste blootstellingsniveau (cumulatieve SEL = 206 dB re 1 $\mu\text{Pa}^2\text{s}$) kwam overeen met 100 pulsen op een afstand van 100 m van een 'typische' Noordzee heilocatie. In geen van de drie larvale stadia werden significante effecten waargenomen.

Het feit dat we geen significante effecten vonden bij 206 dB cumulatieve SEL was opmerkelijk, omdat de VS een interim criterium voor weefselschade in vis <2 gram van 183 dB cumulatieve SEL hanteert. Ook de aanname van 100% sterfte binnen een straal van 1000 m rond een heilocatie, zoals toegepast in de Passende Beoordeling voor Nederlandse offshore windparken, lijkt in het geval van tonglarven te conservatief te zijn. De resultaten van de huidige studie kunnen niet geëxtrapoleerd worden naar vislarven in het algemeen, omdat er interspecifieke verschillen in de kwetsbaarheid voor geluidsblootstelling kunnen zijn. Deze studie geeft echter wel aanwijzingen dat de eerdere aannames en criteria mogelijk aangepast dienen te worden.

1. Introduction

1.1 General introduction

Fish can suffer lethal damage to their swim bladder or other organs due to loud impulse sounds such as pile driving noise. However, detailed dose-response studies are still scarce, especially for the early life stages (Popper & Hastings 2009). While juvenile and adult fish may actively swim away from a sound source, planktonic larvae are passively transported by currents and are therefore not capable of avoiding sound exposure. As a result, fish larvae may suffer more from underwater noise than older life stages.

In view of the rapid extension of offshore wind farms in the North Sea, there is an urgent need to acquire more knowledge on the effects of noise caused by pile driving. The focus of this study was the effect of piling noise on the survival of fish larvae. It was not possible to carry out field experiments within the available resources and time frame of the Shortlist Masterplan Wind (SMW) research programme. But the alternative, laboratory experiments, was hampered by the limitations of reproducing low frequency sounds in confined spaces. Therefore, the first goal of this study was to examine the feasibility of simulating piling noise in a laboratory setting.

If the first goal was achieved, the second goal was to use the laboratory set-up in a pilot study aimed at determining the sound threshold at which mortality in fish larvae occurs. Due to available project resources, the pilot study was limited to lethal effects on the larvae of one fish species, common sole (*Solea solea*), and the study was limited to six experiment days (named trial 1-6). Consequently, the number of exposures, sound parameters and co-variables that could be tested, using sufficient numbers of replicates, was limited.

1.2 Management background

Within the framework of the Appropriate Assessment of Dutch offshore wind farms, a modelling study was carried out to estimate the effect of piling noise on the number of plaice, common sole, and herring larvae that reach the Dutch Natura2000 sites (Prins et al. 2009). For this, an existing larval transport model (Bolle et al. 2005, 2009, Dickey-Collas et al. 2009, Erftemeijer et al. 2009) was expanded with an assumption on larval mortality caused by pile driving. Although it was recognised that insufficient scientific knowledge is available on the relationship between sound exposure and mortality, it was assumed that 100% mortality occurs up to a distance of 1 km from the piling site (Prins et al. 2009). The results of this modelling study indicated a reduction of 0-18% in the number of larvae that reach the Natura2000 sites due to pile driving on specific piling sites.

Subsequently, based on expert-judgment, the model results were extrapolated to other fish species and older life stages in an attempt to assess the effect of offshore piling on the overall prey availability for birds and marine mammals in Natura2000 sites (Bos et al. 2009). This extrapolation indicated that a reduction of more than 5% might occur for seven important prey species: plaice, flounder, herring, sprat, cod, whiting and smelt. These findings contributed to the decision for implementing a mitigation rule on the period of the year in which pile driving is allowed.

Unfortunately, this assessment involved a large number of uncertainties. The first and foremost was the assumption on larval mortality due to pile driving noise. There is large uncertainty about the vulnerability of fish eggs and larvae to piling noise and the spatial scale at which mortality or injury will occur (Popper & Hastings 2009). To address this important knowledge gap, the current pilot study was proposed within the SMW research programme.

1.3 Assignment and boundaries

This SMW project consisted of the development of an experimental set-up and a limited number of exposure-effect experiments using common sole larvae. The effects of pile driving at the population level were not modelled, nor were the results extrapolated to other species or life stages.

1.4 Reading guide

The progress during the project was documented in a series of memoranda. The core information has been extracted from the memoranda and is presented in the report. Therefore the report can be read as a stand-alone document. Nevertheless, the memoranda are presented as Appendices to the report to provide insight in the details and the development of thoughts and methods during this novel research project.

2. Materials and Methods

2.1 Experimental set-up

The objective of the proposed pilot study was to determine whether levels of underwater noise from piling activities can result in mortality in fish larvae. The piling noise should be representative for distances from 100 m to 2 km from the piling installation in an offshore environment. Due to budget and time limitations, which prohibited in situ experiments during actual offshore piling activities, it was decided to execute pilot exposure experiments in which fish larvae are exposed to underwater acoustic signals representative of piling noise, in a laboratory setting. Several options for generating sound signals representative for pile driving noise were evaluated (see TNO Memo 1, Appendix A). It was concluded that the most promising option was to develop an exposure chamber, driven by an underwater loudspeaker. In this so called 'larvaebrator', derived from an existing experimental set-up for larger fish (Lewis et al. 1998), effects of exposing fish larvae to sound pressure and particle velocity can be tested independently.

Metrics

The acoustic signals to which the fish larvae are exposed in the pilot experiments must be representative for the actual noise exposure in the field. This actual exposure will vary with the properties of the piling project and its environment. Therefore, the 'representativeness' is achieved in terms of acoustic metrics that quantify the received signals. In a parallel project in the SMW research programme, standardization of underwater acoustic metrics is pursued (Ainslie 2011). Following the terminology developed in that study, the impact of piling underwater noise on marine life is quantified in terms of Sound Exposure Level (SEL in dB re $1 \mu\text{Pa}^2\text{s}$; per strike and/or cumulative) and peak sound pressure (value in μPa or level in dB re $1 \mu\text{Pa}^2$). Other possible metrics (impulse, rise time, peak to peak sound pressure, kurtosis, etc.) are sometimes suggested, but the associated dose-response relations are even less clear than for SEL and peak pressure. Hence, these other metrics are not considered. Similar metrics can be derived for acoustic particle velocity. Sound particle velocity has a direction associated to it. The metrics proposed here concern the magnitude of the sound particle velocity.

Peak sound pressure is here defined as the maximum absolute value of the unweighted instantaneous sound pressure in the measurement bandwidth. *Peak sound pressure level* is ten times the logarithm to the base 10 of the ratio of the square of the peak sound pressure to the square of the reference sound pressure of $1 \mu\text{Pa}$.

Sound Exposure is defined as the time integral of the time-varying square of the unweighted instantaneous sound pressure in the measurement bandwidth over the duration of a single piling impact. *Cumulative Sound Exposure* is the sound exposure summed over multiple piling impacts. *Sound Exposure Level (SEL)* is ten times the logarithm to the base 10 of the ratio of the sound exposure to the reference sound exposure of $1 \mu\text{Pa}^2\text{s}$.

Peak sound particle velocity is here defined as the maximum absolute value of the unweighted instantaneous total sound particle velocity in the measurement bandwidth. *Peak sound particle velocity level* is ten times the logarithm to the base 10 of the ratio of the square of the peak sound particle velocity to the square of the reference sound particle velocity of 1 nm/s .

Sound particle velocity exposure is defined as the time integral of the time-varying square of the unweighted instantaneous sound particle velocity in the measurement bandwidth over the duration of a single piling impact. *Cumulative sound particle velocity exposure* is the sound exposure summed over multiple piling impacts. *Sound particle velocity exposure level* is ten times the logarithm to the base 10 of the ratio of the sound exposure to the reference sound particle velocity exposure of $1 (\text{nm/s})^2\text{s}$.

Criteria

In 2008, the US Fisheries Hydro-acoustic Working Group has issued an Agreement in Principle for Interim Criteria for Injury to Fish from Pile Driving Activities (Oestman et al. 2009). The agreed criteria identify maximum peak sound pressure levels of 206 dB re 1 μPa^2 and maximum cumulative SEL of 187 dB re 1 $\mu\text{Pa}^2\text{s}$ for all listed fish except those that weigh less than 2 gram. For small fish (<2 gram), the threshold for the cumulative SEL is 183 dB re 1 $\mu\text{Pa}^2\text{s}$. No frequency weighting is mentioned in relation with dose-response relationships for fish.

Based on the available data from measurements carried out by TNO (de Jong & Ainslie 2008) and data from the literature as reviewed in Ainslie et al. (2009), see also Table 1, signals representative of pile driving noise at distances from 100 m to 2 km from the piling installation have an estimated broadband peak sound pressure up to about 32 kPa (peak level 210 dB re 1 μPa^2) and a broadband single impulse SEL up to 188 dB re 1 $\mu\text{Pa}^2\text{s}$. Propagation loss depends in a complex manner on water depth (bathymetry), condition of the water surface (waves) and the acoustic properties. However, for North Sea conditions in 20-25 m deep water with a sandy bottom, distances between 100 m and 2 km from the pile are approximately in the 'mode-stripping' region (Weston 1976). In this region, propagation loss varies with distance R as $15\log R$, hence the levels at 2 km distance are estimated to be about 20 dB lower than the levels at 100 m (i.e. SEL 168 dB re 1 $\mu\text{Pa}^2\text{s}$ and peak level 190 dB re 1 μPa^2).

At larger distances (e.g. corresponding to several water depths) from the pile, the acoustic particle velocity and acoustic pressure levels are approximately related through the characteristic impedance of the medium, i.e. the velocity level in dB re 1 $(\text{nm/s})^2$ equals the pressure level in dB re 1 μPa^2 minus $20\log_{10}\{\rho c \cdot (10^6/10^9)\} \approx 64$ dB. This includes a correction for the factor that accounts for the different reference units. Hence, the corresponding broadband peak sound particle velocity levels are between 127 and 147 dB re 1 $(\text{nm/s})^2$ and the broadband sound particle velocity exposure levels between 104 and 124 dB re 1 $(\text{nm/s})^2\text{s}$.

Some typical underwater piling noise SEL spectra are given in Figure 1, see the properties in Table 1. The spectra of the noise measured at the Q7 site are similar. This shows that the main (unweighted) energy is generated in the 50 Hz to 1 kHz bands.

A closer investigation of wave form and spectral content for a typical piling strike signal confirms that it is sufficient to reproduce the piling noise in the frequency range between 50 Hz and 1 kHz. This analysis is done for piling strike signals, recorded at the North Sea site (depth about 20 m) at a distance of 100 m from the pile. Figure 2 shows the recorded wave form and the resulting wave form after applying a cosine-tapered (Tukey) band-pass filter (1050 points, with 50 Hz taper to zero). It can be seen that the waveform is not significantly affected by the filtering. The resulting SEL and peak levels for the two different bandwidths differ less than 1 dB. Note that the peak level is determined by the negative peak just after 0.1 s.

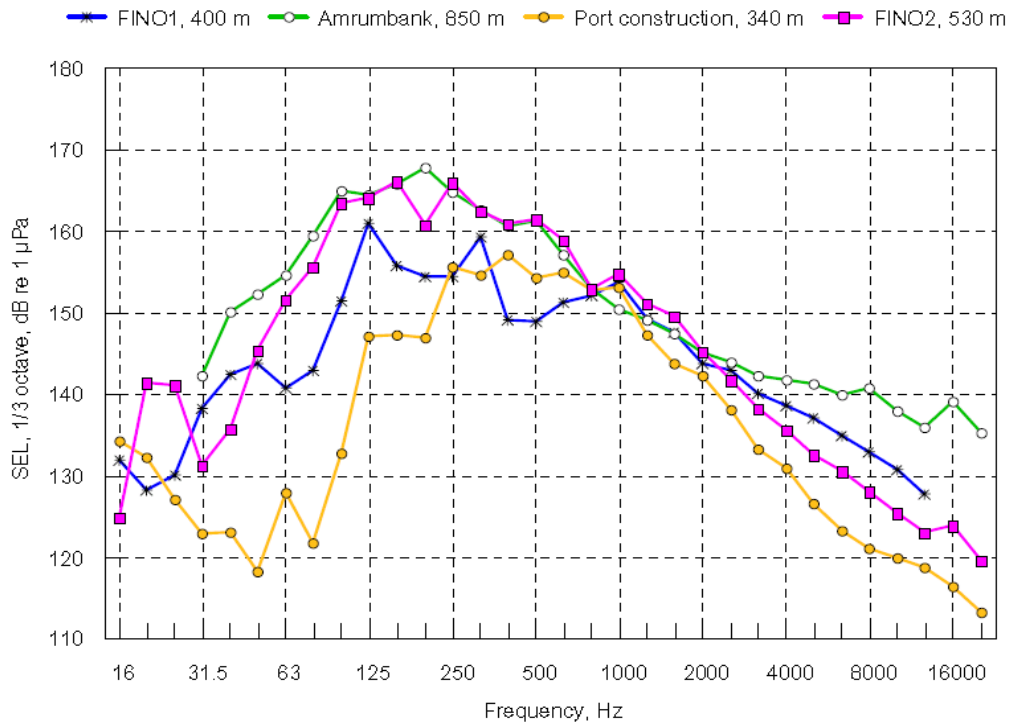

Figure 1 Third-octave band spectra of the single strike SEL (dB re 1 $\mu\text{Pa}^2\text{s}$) of some of the pile-driving operations, from Nehls et al. (2007), see also Table 1

Table 1 Summary of measurement results for different pile driving operations for offshore wind turbines (hollow steel monopiles) from Ainslie et al. (2009). The 'normalized' levels are scaled to a distance of 500 m in 20 m water depth

Project	Pile diameter [m]	Water depth [m]	Measuring depth [m]	Measuring Distance [m]	Blow energy [kJ]	Peak Level [dB re 1 $\mu\text{Pa}^2\text{s}$]	SEL [dB re 1 $\mu\text{Pa}^2\text{s}$]	Normalized Peak Level [dB re 1 $\mu\text{Pa}^2\text{s}$]	Normalized SEL [dB re 1 $\mu\text{Pa}^2\text{s}$]
Jade port construction, Germany, 2005	1.0	11	5	340	70-200	190	164	186	160
FINO 1, Germany, 2001	1.6	30	10	750	80-200	192	162	196	166
FINO 2, Germany, 2006	3.3	24	5	530	300	190	170	191	171
Amrunbank West, Germany, 2005	3.5	23	10	850	550	196	174	200	178
Test Pile, UK, 2006	2.0	8-15	?	57	800	208	178	193	163
Test Pile, UK, 2006	2.0	8-15	4-7	1850	800	188	164	195	171
Q7 site, NL, 2006	4.0	20-25	8-15	890-1200	800	195	172	200	177

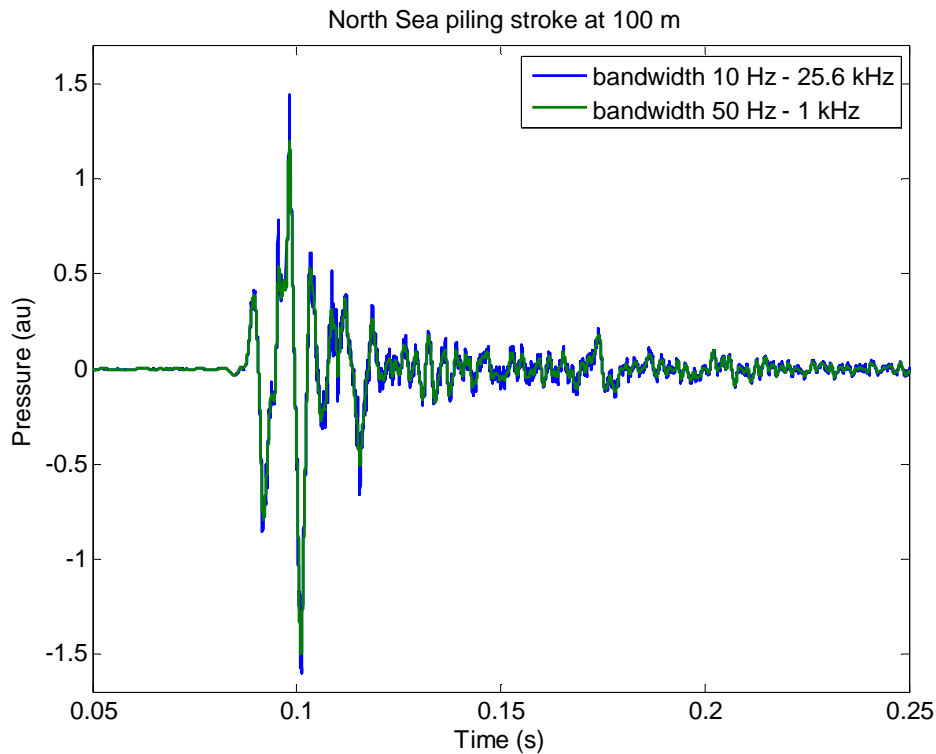

Figure 2 Underwater noise signal for a single strike on a 4 m diameter hollow steel cylindrical monopile, recorded at the North Sea site at a distance of 100 m from the pile, for two different bandwidths. The amplitude scale is not calibrated ('au'='arbitrary unit')

Summarizing the simulated piling noise signals should fulfil the following criteria to be representative:

1. Broadband peak sound pressure level between 190 and 210 dB re 1 μPa^2
2. Difference between broadband SEL and peak level at least -22 dB re 1 s (i.e. SEL between 168 and 188 dB re 1 $\mu\text{Pa}^2\text{s}$)
3. Broadband peak particle velocity level between 127 and 147 dB re 1 $(\text{nm/s})^2$
4. Broadband integrated velocity exposure levels between 104 and 124 dB re 1 $(\text{nm/s})^2\text{s}$.
5. Main energy between 50 Hz and 1 kHz.

The difference between the peak level and SEL accounts for the impulsiveness of the signals. Note that the lower frequency of 50 Hz is probably connected with the cut-off frequency for shallow water sound propagation. For piling in deeper water the lowest frequency of interest may be lower.

The above criteria can be fulfilled by various acoustic signals. Since the actual underwater sound due to pile driving will vary for different piling activities in different environments and also between different piling strikes and at different measurement locations relative to the pile, it is considered sufficient, for the proposed exposure tests, to select specific representative acoustic signals, which fulfil the above criteria. It was decided to play back an actual recording of underwater noise, which was made during the piling for a wind turbine monopile foundation at the North Sea (OWEZ wind farm). Actual recorded data have the benefit that the signals also represent signal characteristics that are not covered by the proposed criteria. Two single strike signal recordings were selected, one from a measurement at a distance of 100 m from the pile and one measured at 800 m distance, for a pile diameter of ca. 4 m in ca. 20 m of water depth, with a strike energy of ca 800 kJ.

Practical design of the experimental set-up

The general 'larvaibrator' design concept consists of an LFPX-4 projector (underwater sound source, Figure 3 left) on which a rigged-walled (28 mm thick) cylindrical chamber (110 mm diameter, 160 mm high) is placed (Figure 3, middle). The chamber is filled with sea water and the larvae. The piston of the projector is also the bottom of the chamber and can directly excite the water with a given signal. Depending on the required boundary conditions, i.e. constant pressure or constant velocity, the top cover (Figure 3, right) of the chamber can be closed (pressure excitation) or released (velocity excitation). The sound pressure in the chamber is measured by four pressure transducers, mounted flush in the wall of the chamber. The sound particle velocity is measured by a waterproof accelerometer, mounted on the piston of the projector. For practical reasons, the velocity excitation is in vertical direction only. In real offshore piling situations, the larvae will probably be excited in horizontal directions. We do not expect that the excitation direction will have an influence on larval mortality.

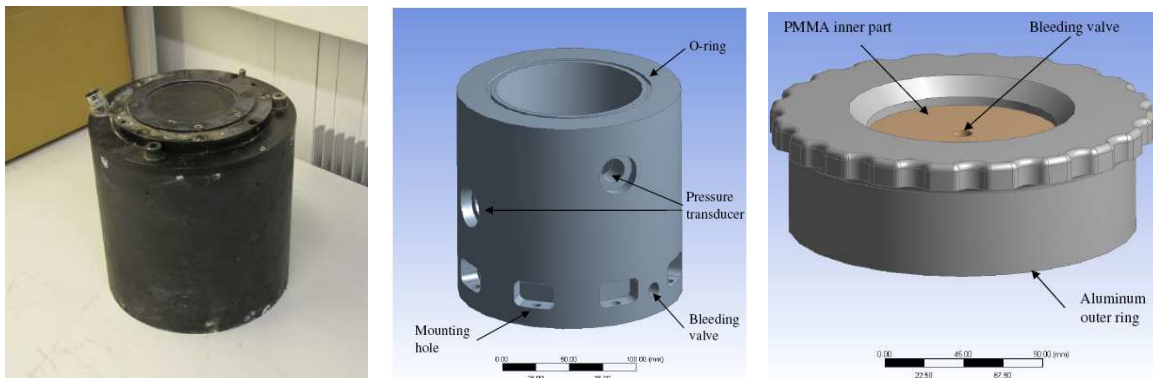

Figure 3 LFPX-4 projector (left), compact chamber for larvae (middle) and top cover (right)

Later an additional specification was added to the design requirements of the test setup: for both the velocity and pressure source test conditions it should be possible to introduce a static overpressure inside the chamber, varying between about 0.2 and a maximum of 3 bar. This overpressure should better simulate the variety of underwater conditions at the range of depths at which the larvae are situated. Figure 4 shows the final set-up. See TNO memoranda 2 and 3 (Appendix C-D) for further details.

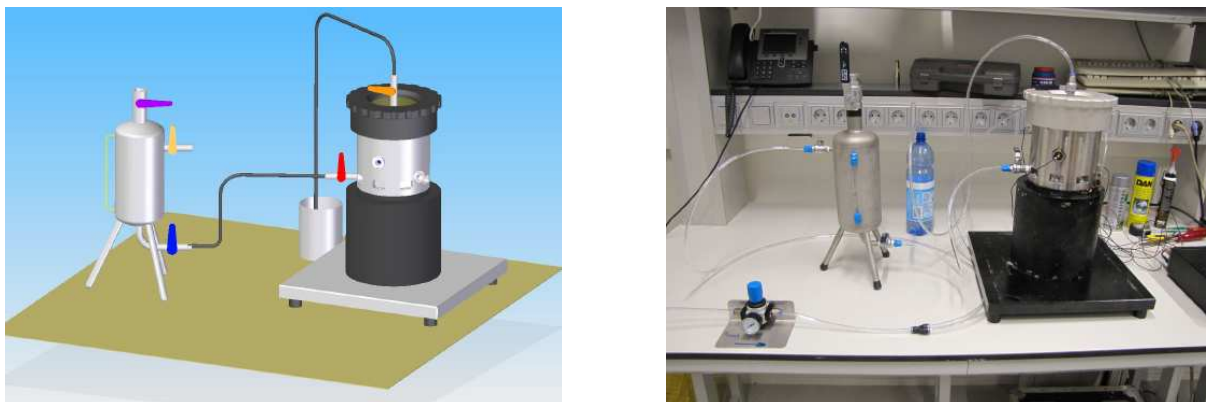

Figure 4 A 3D impression of the experimental test setup (left) and laboratory test setup with projector and larvae chamber, reservoir and pressure regulator (right)

Piling noise signals

Two measured noise signals are selected to excite the water in the chamber, one at 100 m and one at 800 m from a pile at the OWEZ wind farm. The amplitude will be varied in 4.5 dB steps, which each roughly corresponds with doubling of the distance to the pile (see Table 2).

Table 2 Sound levels at different distances

Distance m	Peak pressure level dB re 1 mPa ²	Single strike SEL dB re 1 mPa ² s	Peak velocity level dB re 1 (nm/s) ²	Single strike velocity exposure level dB re 1 (nm/s) ² s	Wav-file
100	210	188	147	124	pressure_100m_filter.wav
200	205	183	142	119	pressure_100m_filter.wav
400	201	179	138	115	pressure_100m_filter.wav
800	196	174	133	110	pressure_800m_filter.wav
1600	192	170	129	106	pressure_800m_filter.wav
3200	187	165	124	101	pressure_800m_filter.wav

Testing

The experimental set-up (filled with clean tap water) was tested at the maximum achievable acoustic level in four different configurations:

- a Velocity excitation at 0 bar overpressure*
- b Velocity excitation at 2 bar overpressure*
- c Pressure excitation at 0 bar overpressure*
- d Pressure excitation at 2 bar overpressure*

In each configuration the modified wav-file of the 100 m recording was sent to the projector at a level close to the maximum allowable level for the projector. The resulting acoustic signals in the chamber were measured by the accelerometer on the piston and by the four pressure transducers in the wall of the chamber.

The results are shown in Figures 5 and 6. Note that the pressure sensors are numbered from bottom (close to the piston) to top.

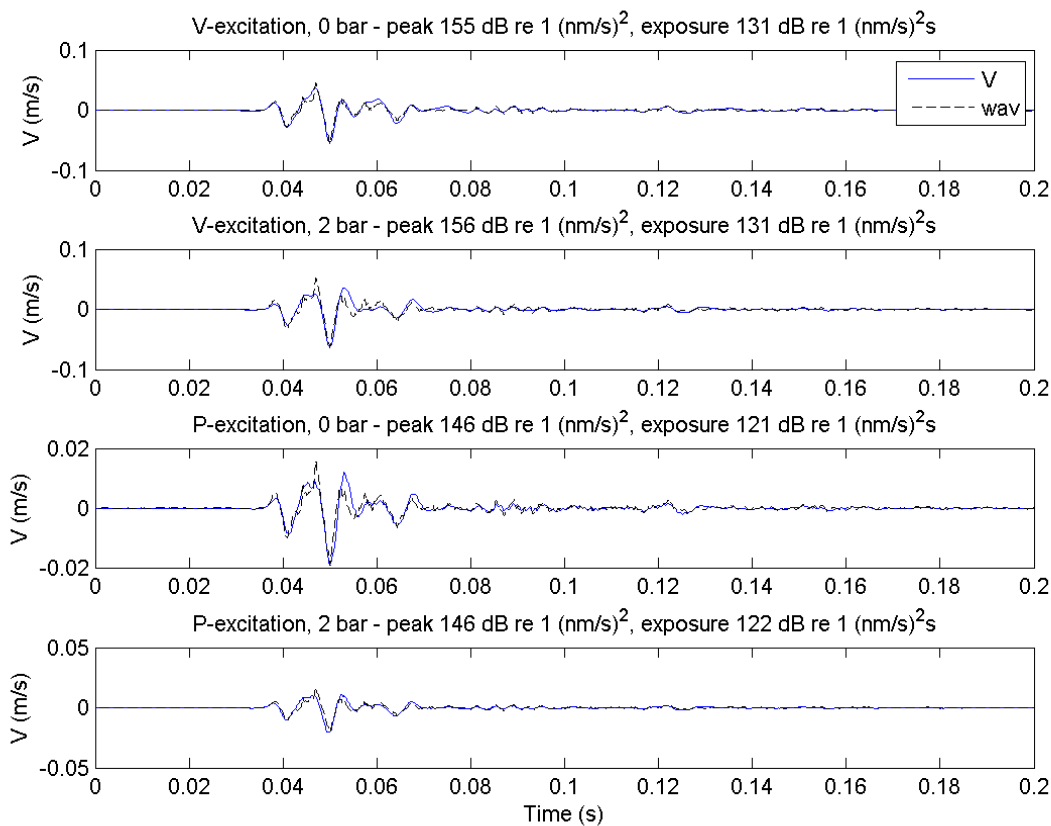

Figure 5 The sound velocity of the piston of the projector for the four different excitation configurations. The black dashed line is the waveform of the wav-file, scaled to match the peak level of the measured velocity (blue line). The header gives the peak and integrated particle velocity levels that were obtained in these tests. These may be considered the maximum achievable levels

The piston reproduces the original recorded wav-files quite accurately. The velocity levels are substantially higher for a velocity excitation compared to a pressure excitation. The maximum achievable velocity levels (in velocity excitation configuration) are about 8 dB higher than required for this study (see Table 2). Hence the effect of particle velocity can be examined decoupled from the effect of sound pressure.

In case of pressure excitation, the velocity levels are relatively high, probably due to remaining flexibility (air/membrane) in the chamber, which means that the set-up does not enable to examine the effect of sound pressure decoupled from particle velocity. The observed pressure to velocity ratio is actually close to the ratio in a plane wave in unbound water. In a plane wave the acoustic particle velocity and acoustic pressure levels are approximately related through the characteristic impedance of the medium, i.e. the velocity level in dB re 1 (nm/s)² equals the pressure level in dB re 1 μPa^2 minus $20\log_{10}(\rho c/1000) \approx 64$ dB. This includes a correction factor that accounts for the different reference units for pressure and velocity. In water with sound velocity $c = 1500$ m/s and density $\rho = 1000$ kg/m³, the measured peak pressure of 211 dB re 1 μPa^2 corresponds with a free field peak velocity of 147 dB re 1 (nm/s)² and the measured SEL of 185 dB re 1 $\mu\text{Pa}^2\text{s}$ corresponds with a sound particle velocity exposure of 121 re 1 (nm/s)²s. These do not differ more than 1 dB from the measured levels, so the exposures represent realistic pressure to velocity ratios.

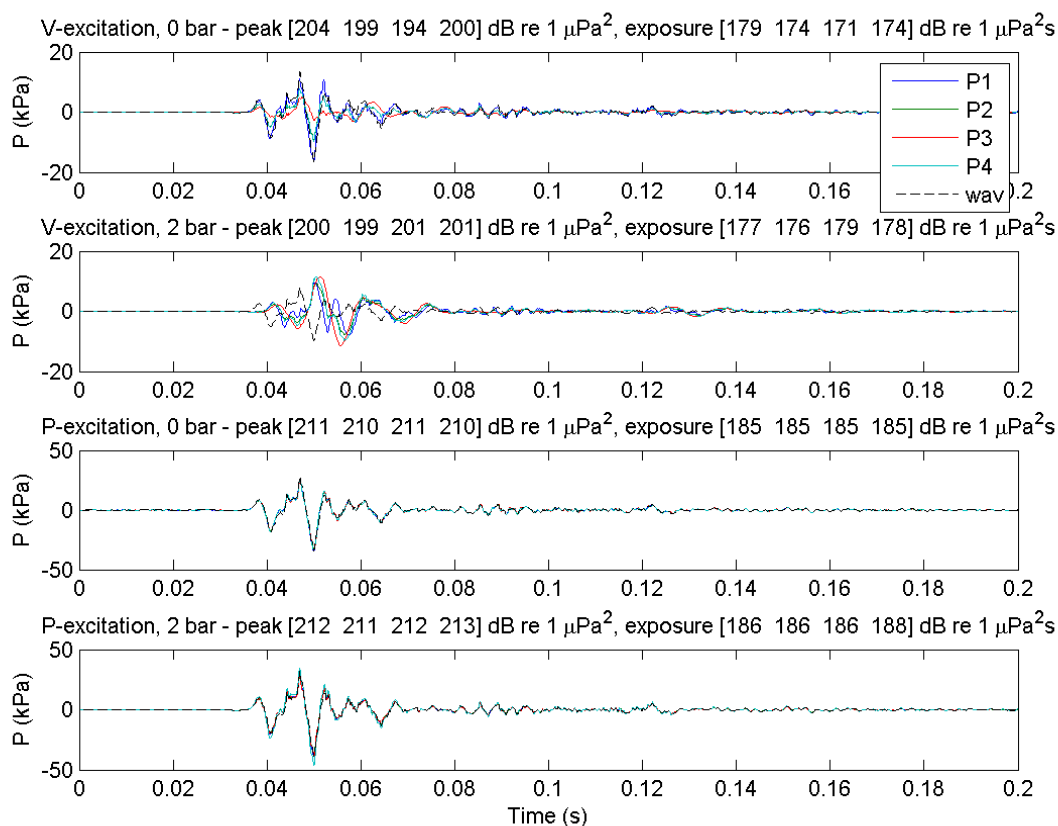

Figure 6 The sound pressure at the four sensors in the larvaebator chamber for the four different excitation configurations. The black dashed line is the waveform of the wav-file, scaled to match the peak level of the measured pressure at sensor 2. The header gives the peak and integrated pressure levels that were obtained in these tests. These may be considered the maximum achievable levels

It can be seen that the sound field reproduces the original recorded wav-files quite accurately in case of pressure excitation (the two lower figures). The pressure distribution in the chamber is very homogeneous in that configuration. The maximum achievable pressure levels for pressure excitation are about 1-2 dB higher than required for this study (see table 1). In case of maximum velocity excitation, the pressure levels are 8-13 dB lower than in case of pressure excitation. Because the required velocity levels are about 8 dB lower than the maximum velocity levels, it follows that the pressure levels in case of velocity excitation are negligibly small, compared to the levels for pressure excitation.

So the two different excitation types create two very different exposures:

- a Predominant velocity excitation
- b Pressure and velocity excitation at a ratio in the same order of magnitude as the ratio in acoustic waves in unbound water

Figure 7 and 8 show that the main characteristics of the frequency spectra of pressure and velocity are reproduced to an acceptable level. The reproduced sound particle velocity spectrum at frequencies above ca 250 Hz is lower than the spectrum of the recorded sound, but the dominant energy in the range between 63 Hz and 250 Hz is reproduced correctly.

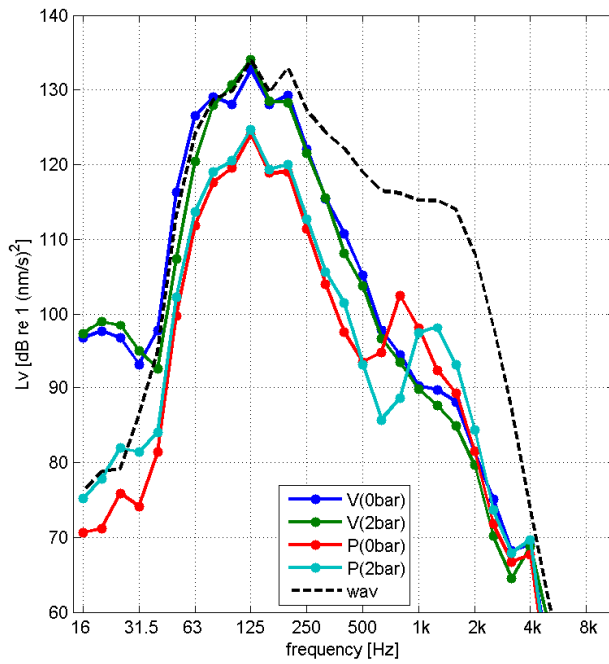

Figure 7 Mean square sound particle velocity level spectrum (in 1/3-octave bands, averaged over the 0.2 s interval plotted in figure 5) for the four configurations, compared with the spectrum of the wav-file, scaled to match the peak level of the measured velocity

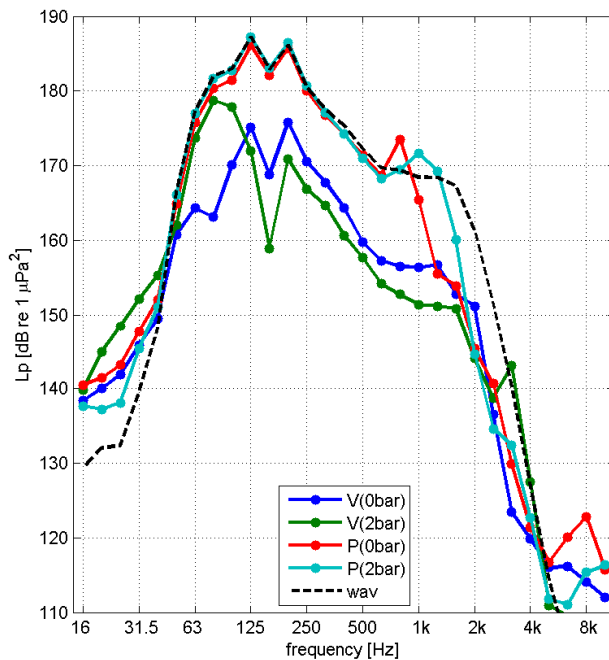

Figure 8 Mean square sound pressure level spectrum of sensor 2 (in 1/3-octave bands, averaged over the 0.2 s interval plotted in figure 6) for the four configurations, compared with the spectrum of the wav-file, scaled to match the peak level of the measured pressure

2.2 Fish larvae

Species selection

Fish larvae can be reared in the laboratory; this has been done successfully for a number of species. However, laboratory rearing is time consuming and, moreover, the availability of eggs and sperm is restricted to the natural spawning period. Therefore laboratory rearing was not an option for the SMW research programme.

Fish larvae of a limited number of species can be obtained from commercial hatcheries. For this pilot study we chose common sole larvae obtained from a hatchery in IJmuiden (SOLEA BV), because of the high frequency of spawning episodes in this hatchery and for practical reasons (vicinity to IMARES laboratory). The high frequency of spawning episodes enabled several trials within the time span of the SMW research programme.

As this pilot study was limited to one species, conclusions on interspecific differences in the impact of piling noise cannot be given. For adult fish there are indications that the impact of sound may depend on the species (Hastings & Popper 2005).

Larval stages

The effect of sound exposure may vary between larval stages related to the development of organs. Three stages were used in the experiments: larval stages 1, 2 and 3-4a (Figure 9). Classification of larval stages differs slightly between publications; Ryland (1966) is usually applied in flatfish research, but Al-Maghazachi & Gibson (1984) is more frequently used in the literature on common sole. Therefore the classification according to Al-Maghazachi & Gibson (1984) was used in this study:

- Stage 1 (a-d): Yolk sac present
- Stage 2 (a-c): Yolk sac absorbed or remaining as oil globule, development of spines and swim bladder.
- Stage 3 (a-b): Swim bladder fully inflated, appearance of fin rays, notochord straight
- Stage 4 (a-d): Onset of asymmetry and eye migration, notochord bent
- Stage 5 (a-d): Completion of metamorphosis, swim bladder resorbed.

Larval stage duration depends on temperature (Fonds 1979, Boulhic et al. 1992, Amara et al. 1993). The larvae were reared in the IMARES laboratory at temperatures between 12 and 16°C; within this range the temperature was manipulated so the majority of larvae would be in the required developmental stage on the day of the experiments. On average, stage duration was 3-4 days for stage 1, ± 7 days for stage 2 and ± 5 days for stage 3. Variation in development rates was observed between batches and between larvae within the same batch.

In stage 3-4a larvae, inflated swim bladders were observed in most, but not all larvae. Similar observations were done by Boulhic & Gabaudan (1992) and Palazzi et al. (2006). Palazzi et al. (2006) observed inflated swim bladders at 16 days after hatching in common sole larvae reared at 18°C (Figure 10, right panel), but also reported that an inflated swim bladder was not present in all larvae of that age. Boulhic & Gabaudan (1992) examined histological samples of common sole larvae reared at 19°C. They reported that the gas gland and bladder are already developed 5 days after hatching, the first inflated swim bladders appear at 10 days after hatching, and not all larvae have an inflated bladder during the inflation period. In many larvae they observed a dilated pneumatic duct when the swim bladder begins to inflate, indicating passage of gas from the digestive tract to the swim bladder (physostomous), but they also found indications that inflation may be realised by gas secretion of the epithelium of the gas gland.



Figure 9 Larval stages used in the experiments: stage 1 – 5.3 mm (top left), stage 2 – 6.0 mm (top right), stage 3 – 6.5 mm (bottom left) and stage 4a – 7.1 mm (bottom right)

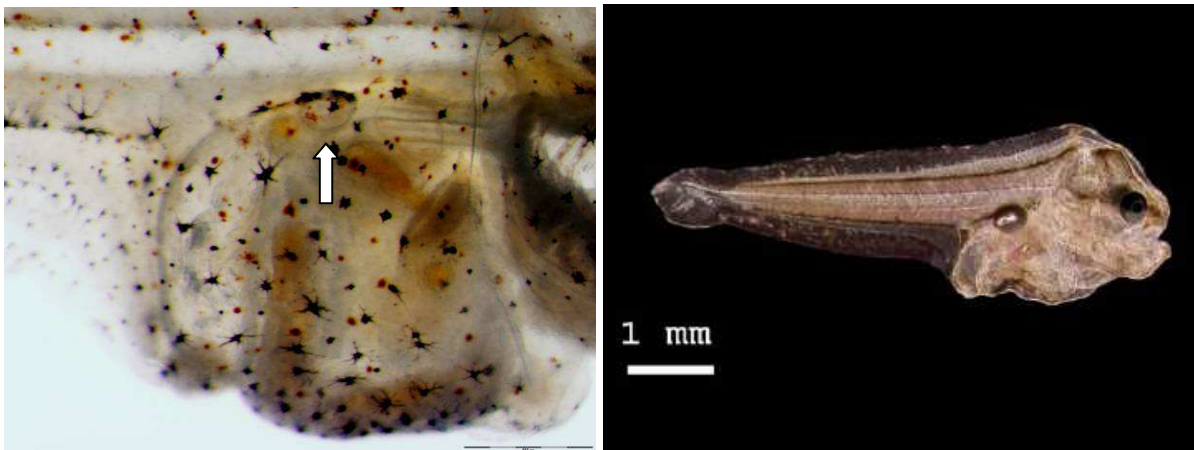

Figure 10 Swim bladder as observed in this study in a stage 4a larva (left) and photo published by Palazzi et al. (2006) showing the swim bladder in a stage 4a larva (right)

Larval distribution

The effect of sound exposure may vary with static pressure, i.e. the depth at which the larvae occur. No studies on the vertical distribution of common sole larvae have been carried out in the North Sea. A North Sea and Irish Sea study on the planktonic stages of other fish species showed that, overall, larvae occur in the entire water column with higher concentrations in the top water layers (<25m), but this study also showed interspecific differences (Conway et al. 1997).

Vertical distribution of common sole has been examined in other areas, but most of these studies focused on the transition from pelagic to demersal life style and only discriminated between the bottom water layer (1-1.5m above seabed) and the rest of the water column (e.g. Lagardère et al. 1999, Grioche et al. 2000). Only one study, carried out in the Bay of Biscay, presented data on the distribution of common sole larvae in the entire water column (published in Koutsikopoulos et al. 1991 and Champalbert & Koutsikopoulos 1995). This study showed that the early larval stages (stage 1-2) mainly occur in the bottom half of the water column, whereas the later stages (stage 3-4) occur in the whole water column. A diel vertical migration pattern is observed in which the larvae move up in the water column at night and down during daytime. This pattern was clearly observed in larval stages 3 and 4, but was less evident for the stages 1 and 2. By stage 5, the larvae disappeared from pelagic catches and were only observed close to the seabed.

In the Bay of Biscay, common sole spawning grounds are offshore (Arbault et al. 1986, Koutsikopoulos & Lacroix 1992), whereas in the North Sea, common sole spawn within the 50m depth contour (Houghton & Riley 1981, Riley et al. 1986, van der Land 1991) and major spawning activity is observed at a depth of 10-25m (Bolle et al. in prep). Taking into account both the vertical distribution pattern observed in the Bay of Biscay and the geographical distribution of spawning in the North Sea, we concluded that the majority of common sole larvae will occur at a depth of 5-20m.

Protocol

Test trials were carried out prior to the actual exposure experiments to develop a protocol for larvae rearing, larvae maintenance and scoring survival. The protocol was further refined based on experience gained during the first exposure experiments.

Batches of eggs were obtained from the hatchery directly after spawning. The eggs and larvae were reared to the required developmental stage in large cultivation chambers at the IMARES laboratory. The temperature was slowly raised from the temperature in the hatchery (12°C) to the ambient temperature in the IMARES laboratory (16°C). Advantage of rearing the larvae at IMARES, rather than obtaining larvae shortly before the experiment, is that the developmental stage can be manipulated by temperature adjustments.

Ample larvae were carefully collected from the cultivation chamber using a small container. The required number of larvae were selected from this container and inserted into the test chamber of the experimental set-up. After the treatment, the larvae were transferred to a small container and examined for instantaneous effects. The water in the test chamber was refreshed before the next experiment was carried out.

The larvae were transferred to and from different water bodies using a plastic pipette, from which the tip was cut off to enlarge the opening. This method minimised mortality due to handling. It is however a time consuming method as only one to three larvae can be transferred at the same time. Transferring 25 larvae to and from the test chamber took approximately 10-15 minutes.

After the experiments, the batches of larvae were held separately in small containers for a period of 7-12 days. Larvae are vulnerable to mechanical damage, therefore no aeration was used in the small batch-containers. The water in the containers was refreshed each day, because the containers were not aerated, and because of the need to remove old food. The quickest and most effective way of doing this was by transferring the larvae to a new batch-container. While doing this the number of dead and live larvae was enumerated. Dead larvae were removed from the batch-containers.

The duration of the yolk-sac stage is 3-4 days (at 12-16°C); the larvae start feeding at an age of 3-4 days after hatching. Food was provided each day from 3-4 days after hatching onwards. Young larvae were fed with 1-day-old copepods. Older larvae were fed with 2-day-old 'enriched' copepods; these copepods were fed for 1 day with algae to increase their nutritional value and size. This larval diet was sustained until metamorphosis. The food items were provided *ad libitum*.

The numbers of dead and live larvae were counted each day. Each container was examined at the same time of day (± 1 hour). Dead larvae disintegrate completely within 24 hours. Recently died larvae were visually recognized by their shape or immobility. Within a few hours after death, a larva shrivels up and its shape indicates that it is dead (Figure 11). Immobile larvae were viewed using a microscope or a magnifying glass to examine heart-beat and respiratory activity.

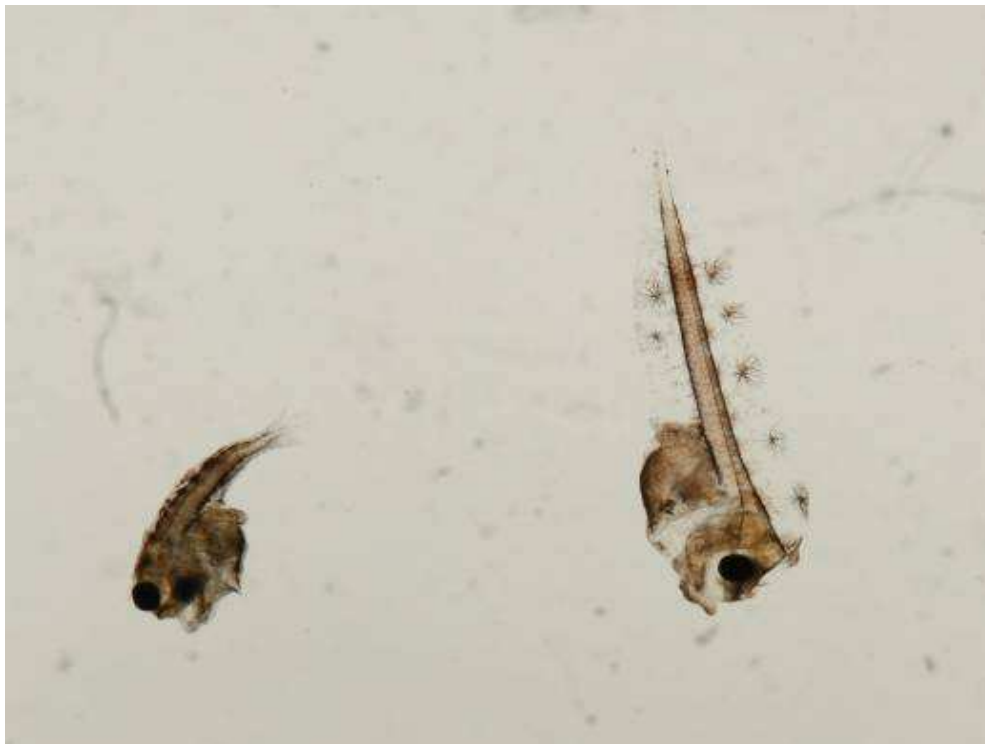

Figure 11 Left: dead larva, right: live larva

All live larvae at the end of the monitoring period were preserved (by trial and treatment) to enable future examination of physiological damage. The larvae were preserved in 3.6% formaldehyde solution for histology or in a glutaraldehyde-formaldehyde solution. These preservation methods allow both light microscopy and SEM analyses.

All procedures were carried out by one of 3 trained technicians/scientists. No bias in survival rate was observed related to the person operating the procedures.

Animal Ethical Commission (DEC)

The experiments carried out in the present study on (post yolk sac) fish larvae required a license. Experiment code 2010085 under application 2010063.c was granted positive advice by the Animal Ethical Commission (DEC).

2.3 Initial series of experiments

Three trials (experiment days) were carried during the initial series of experiments. Different larval stages were used in each trial: stage 1, stage 2 and stage 3-4a. The larvae used in each trial were obtained from different spawning batches; all larvae within a trial were from the same spawning batch.

Originally we intended to use two values for overpressure: 0.5 and 2 bar to simulate a water depth of 5 and 20 m, corresponding to the depth range in which the major density of common sole larvae is expected (see section 2.2). An overpressure of 0.5 bar was used in the first trial. The second trial was started with an overpressure of 2 bar, but due to technical problems this had to be changed to 0 bar after 4 experiments. These four experiments were excluded from the analyses. The remainder of the experiments in trial 2 and 3 were carried out at 0 bar overpressure.

Two types of sound exposure were applied: pressure excitation or velocity excitation (see section 2.1). The larvae were exposed to single or multiple strikes. Sound pressure was expressed in peak pressure level (dB re 1 μPa^2), sound exposure level (SEL, dB re 1 $\mu\text{Pa}^2\text{s}$) and cumulative SEL (dB re 1 $\mu\text{Pa}^2\text{s}$). Sound particle velocity was expressed in peak velocity level (dB re 1 $(\text{nm/s})^2$), velocity exposure level (dB re 1 $(\text{nm/s})^2\text{s}$) and cumulative velocity exposure level (dB re 1 $(\text{nm/s})^2\text{s}$). The sound parameters were related to the distance from a 'typical' North Sea piling site (see section 2.1) and, in the case of cumulative parameters, to the number of strikes. The maximum cumulative SEL possible with the experimental set-up was 207 dB, corresponding to 100 strikes at 100 m. The sounds were played back from an original recording of piling noise at a North Sea location. The strike rate was 50 strikes per minute, so a total exposure to 100 strikes lasted 2 minutes. The total duration of the experiment including handling of the larvae was 10-20 minutes (see section 2.2).

Two control groups were included in each of the three trials. The first control group (control 1) received exactly the same treatment as the exposure groups, save the sound exposure itself. The second control group (control 2) was not inserted in the test chamber but otherwise received the same treatment.

Each trial (experiment day) consisted of a number of treatments. A treatment can be either an exposure or a control. Each treatment was repeated in a number of experiments. The number of replicates (experiments per treatment) ranged from two in trial 1 to five in trial 3. The batch size (number of larvae) per experiment was set at 25 (trial 1 and 2) or 28 (trial 3).

The response variable that was measured was mortality. The numbers of dead and live larvae in each batch were scored directly after the experiment and daily until 10-12 days after the experiment. The batch-containers were coded and, except for the observations directly after the experiments, the person scoring mortality was not aware of the treatment belonging to the code.

Trial 1

The aim of the first trial was to examine the sensitivity range, as little is known about critical values for sound parameters with regard to larval survival. Hence we chose to maximise the number of treatments and minimise the number of replicates per treatment. A test scheme was designed in which each exposure depended on the results of the previous exposure. This iterative approach is the most effective way to find critical sound exposure levels, but it depends on immediate visible effects (i.e. directly after the experiment). Such effects were not observed. Eight treatments (6 exposures and 2 controls) were applied. Each treatment was carried out in duplicate (with 1 exception, Table 3).

Table 3 Treatments applied in trial 1. Larval stage 1, overpressure = 0.5 bar for all treatments except control 2 (0 bar) and batch size per experiment = 25 (± 2) larvae

Treatment	Velocity or pressure excitation	Distance	No. of strokes	No. of replicates	Peak pressure level	SEL	Cumulative SEL	Peak velocity level	Velocity exposure level	Cum. velocity exposure level
		m			dB re 1 μPa^2	dB re 1 $\mu\text{Pa}^2\text{s}$	dB re 1 $\mu\text{Pa}^2\text{s}$	dB re 1 $(\text{nm/s})^2$	dB re 1 $(\text{nm/s})^2\text{s}$	dB re 1 $(\text{nm/s})^2\text{s}$
control 1				2	0	0	0	0	0	0
control 2				2	0	0	0	0	0	0
sound exposure	P	800	1	2	197	173	173	133	108	108
sound exposure	P	100	1	2	211	187	187	147	122	122
sound exposure	P	100	50	2	211	187	204	147	122	139
sound exposure	V	800	1	2	183	158	158	133	110	110
sound exposure	V	100	1	3	197	172	172	147	124	124
sound exposure	V	100	100	2	197	172	192	147	124	144

Trial 2

High batch variability (variability in mortality between batches with the same treatment) was observed in trial 1, both in the exposure groups as well as in the control groups (Figure 13). Therefore the number of replicates per treatment was increased in trial 2, at the expense of the number of exposures. The iterative approach was reduced to one initial experiment (100m, 1 strike) and two follow-up scenarios. No immediate visible effects were observed in the first experiment. The follow-up scenario consisted of seven treatments (5 exposures and 2 controls). The number of replicates for each treatment was increased to four (with one exception, Table 4). The treatments were applied in random sequence to avoid bias due to potential serial effects in batch variability.

The first four experiments are not included in Table 4 and in the further analyses. These experiments were done at 2 bar overpressure. The airbag device used for overpressure failed during the 4th experiment; therefore the first three experiments from the follow-up scenario were repeated with 0 bar overpressure.

Table 4 Treatments applied in trial 2. Larval stage 2, overpressure = 0 bar and batch size per experiment = 25 (± 2) larvae

Treatment	Velocity or pressure excitation	Distance	No. of strokes	No. of replicates	Peak pressure level	SEL	Cumulative SEL	Peak velocity level	Velocity exposure level	Cum. velocity exposure level
		m			dB re 1 μPa^2	dB re 1 $\mu\text{Pa}^2\text{s}$	dB re 1 $\mu\text{Pa}^2\text{s}$	dB re 1 $(\text{nm/s})^2$	dB re 1 $(\text{nm/s})^2\text{s}$	dB re 1 $(\text{nm/s})^2\text{s}$
control 1				4	0	0	0	0	0	0
control 2				5	0	0	0	0	0	0
sound exposure	P	200	200	4	206	182	205	142	117	140
sound exposure	P	100	50	4	211	187	204	147	122	139
sound exposure	P	100	100	4	211	187	207	147	122	142
sound exposure	V	200	200	4	192	167	190	142	119	142
sound exposure	V	100	100	4	197	172	192	147	124	144

Trial 3

The same approach was chosen for trial 3 as for trial 2, which is one initial experiment (100m, 1 strike) and two follow-up scenarios with treatments in randomised sequence. Again, no immediate visible effects were observed in the first experiment. Seven treatments (5 exposures and 2 controls) were applied. The number of replicates for each treatment was further increased to five (with one exception, Table 5). The first experiment (100m, 1 strike) is not included in Table 5 and in the further analyses (only 1 replicate).

Table 5 Treatments applied in trial 3. Larval stage 3-4a, overpressure = 0 bar and batch size per experiment = 28 (± 2) larvae

Treatment	Velocity or pressure excitation	Distance	No. of strokes	No. of replicates	Peak pressure level	SEL	Cumulative SEL	Peak velocity level	Velocity exposure level	Cum. velocity exposure level
		m			dB re 1 μPa^2	dB re 1 $\mu\text{Pa}^2\text{s}$	dB re 1 $\mu\text{Pa}^2\text{s}$	dB re 1 $(\text{nm/s})^2$	dB re 1 $(\text{nm/s})^2\text{s}$	dB re 1 $(\text{nm/s})^2\text{s}$
control 1				5	0	0	0	0	0	0
control 2				5	0	0	0	0	0	0
sound exposure	P	100	10	4	211	187	197	147	122	132
sound exposure	P	200	300	5	206	182	207	142	117	142
sound exposure	P	100	100	5	211	187	207	147	122	142
sound exposure	V	200	300	5	192	167	192	142	119	144
sound exposure	V	100	100	5	197	172	192	147	124	144

2.4 Power analysis

Design power analysis

The results of the initial series of experiments were used in a statistical power analysis to estimate the number of replicates required in further experiments. The power (probability of detecting an effect significantly at the 95% level, given a certain sample size and experimental design) depends on the magnitude of the effect to be detected. The magnitude of an effect considered to be relevant in this study is a "50% effect", i.e. the number of larvae surviving in the exposure group = 50% of the number of larvae surviving in the control group (equation 1). Note that with this definition of the effect to be detected, the relative difference between the exposure group and control group depends on the mortality rate in the control group.

(1) % effect = $(p_E - p_C) / (1 - p_C)$ in which p_E is the estimated mean probability of death in the exposure group and p_C is the estimated mean probability of death in the control group

Both the mortality in the control group, as well as the variance observed between batches with the same treatment, varied between trials and increased with duration of monitoring. Therefore separate power analyses were carried out for each trial and for two durations of monitoring (T=5 or 10 days). In trial 3 hardly any larvae had died after 5 days, therefore only T=10 days was included in the analyses. The power was computed for 25 or 50 larvae per batch, and for 5, 10, 15, 20 or 30 replicates per treatment.

The statistical power analysis was based on a generalised linear mixed model with random effects. The logit transformed probability of death (p in treatment i and batch j) was modelled as a function of treatment and random batch effect (α) (equation 2). The number of dead larvae (k) is binomially distributed depending on the probability of death (p) and the number of larvae at the beginning of the experiment (N) (equation 3). The random batch effect (α) is normally distributed (equation 4).

$$(2) \text{ logit}(p_{ij}) = \text{treatment}_i + \alpha_j$$

$$(3) k_{ij} \sim \text{Bin}(p_{ij}, N_{ij})$$

$$(4) \alpha_j \sim N(0, \sigma^2)$$

The variance was estimated in SAS (glimmix procedure, degrees of freedom method = Kenward-Roger). The power was estimated in R (based on 1000 iterations for each separate analysis).

In trial 1 at $T=5$ and in trial 3, the postulated effects were higher than the observed effects. As batch variance increases with mortality, using the observed variance would underestimate the number of replicates required. Therefore the batch variance observed in trial 2 at $T=10$ was used in these cases.

A different approach is required to estimate the probability (given a certain sample size and experimental design) that a large effect can be *excluded* (with 95% confidence) if the real underlying effect is small. Therefore a second series of analyses was carried out to estimate the probability that a 50% effect can be excluded (with 95% confidence) if the actual effect is small (set at 10%).

Results power analysis

The power analyses showed that the probability of detecting a 50% effect (as described above) is low (8-60%) with 5 replicates and 25 larvae per batch, i.e. the number of larvae per batch and the maximum number of replicates used in the first 3 trials.

Due to the high batch variance, doubling the number of replicates improves the power far more than doubling the number of larvae per batch.

Random batch variance increases with duration of the monitoring period. Hence, the statistical power for detecting a difference between the control group and the exposure group is higher at $T=5$ days than at $T=10$ days. This provides an argument for reducing the monitoring period to 5 days. However, if the effect occurs after 5 days then it will be missed if the monitoring period is reduced. Furthermore, extended monitoring provides additional confidence in the observed effects despite that this not quantified in the statistical significance.

Using fifteen replicates for each treatment and 25 larvae per batch gives a high probability of detecting a 50% effect significantly at the 95% level (power estimates at $T=5$ for stage 1 and 2 larvae and at $T=10$ for stage 3-4a larvae):

	Stage 1	Stage 2	Stage 3-4a
Power	96%	97%	100%

Fifteen replicates for each treatment and 25 larvae per batch also gives a reasonably high probability of excluding a 50% effect if the real effect is small (power estimates at T=5 for stage 1 and 2 larvae and at T=10 for stage 3-4a larvae):

	Stage 1	Stage 2	Stage 3-4a
Power	78%	76%	85%

This means that with 15 replicates, given the postulated 50% effect and the estimated variation between batches, there is only a small risk (<5%) that an estimated treatment effect will not be significant at the 95% level. However, there is still some risk (estimated between 15 and 24%) that a treatment effect as large as 50% cannot be excluded at the 95% significance level if the true effect is small.

The analyses suggest that a lower number of replicates may be sufficient for stage 3-4a larvae. This is a result of the low mortality observed in the control group in trial 3 and, consequently, the relatively large difference between exposure and control group in the case of a 50% effect. If this low control-group-mortality is solely related to larval stage, then similar values can be expected in future experiments using stage 3-4a larvae. However, other factors (such as egg quality) are also likely to play a role and control-group-mortality may be higher in future experiments. Therefore using 15 replicates is also advised for stage 3-4a larvae.

2.5 Second series of experiments

Additional experiments were proposed to test the statistical significance of a limited number of exposures. The goal was to attain certainty about the (absence of) effects observed in the first three trials. The statistical power analyses showed that the significance of a 50% effect can be tested with 15 replicates (with 25 larvae per batch). The available budget allowed a maximum of three additional experiment days. Based on the experience gained during the first three trials, 30 experiments (with 25 larvae per batch) can be carried out in one day using the larvaebator, that is two treatments replicated 15 times.

The methodologically correct way to treat a control group is to apply exactly the same procedure as in the exposure groups. Two control groups were included in each of the first three trials: control group 1 received exactly the same treatment as the exposure groups; control group 2 received the same treatment, but was not inserted into and retrieved from the test chamber. The procedure of placing larvae into the test chamber is time consuming and determines the number of experiments that can be done in a day. Despite the extra handling, mortality was the same or lower in control group 1 compared to control group 2 (Figure 12 and 13). Therefore it was decided not to insert the control group larvae in the test chamber during the second series of experiments. This enabled three treatments per day: two exposures using the larvaebator and 1 control group without using the larvaebator.

It was decided to spend 1 experiment day (trial) on each of the three larval stages that were used in the previous trials (stage 1, stage 2 and stage 3-4a). Larval stage is considered to be important, because if differences occur between larval stages in their response to sound (as indicated in the first 3 trials), then this will influence the effect of sound at the population level. The larvae used in each trial during the second series of experiments were obtained from one spawning batch.

All experiments were carried out without overpressure (simulating a water depth of 0 m) to be consistent with the previous trials. Furthermore, the greatest effect of sound pressure is expected to occur at a low static pressure. Tom Carlson showed that the effect of noise was inversely related to static pressure (unpublished data presented at the symposium 'Effects of noise on aquatic life', August 2010).

The exposures were limited to pressure-excitation exposures, because the previous trials indicated that this may affect survival. There were no indications that velocity-excitation exposures may affect survival (Figure 12 and 13). The same two exposures were used in all three additional trials (Table 6): the highest exposure possible with experimental set-up (~ 100 m, 100 strikes) and an exposure which was 5 dB lower in both cumulative SEL and peak pressure (~ 200 m, 100 strikes).

The three treatments (2 exposures and 1 control) in each trial (experiment day) were applied in random sequence and this was repeated 15 times.

The response variable that was measured was mortality. The numbers of dead and live larvae in each batch were scored directly after the experiment and daily until seven days after the experiment. The monitoring period was reduced compared to the initial series of experiments based on the results of the power analysis (section 2.4). This analysis indicated that a monitoring period of five days may be sufficient. However, to be certain that potential effects would not be missed, a monitoring period of seven days was chosen in the second series of experiments. The batch-containers were coded and, except for the observations directly after the experiments, the person scoring mortality was not aware of the treatment belonging to the code.

Table 6 Treatments applied in trial 4 (larval stage 1), trial 5 (larval stage 2) and trial 6 (larval stage 3-4a). Overpressure = 0 bar and batch size per experiment = 25 (±2) larvae

Treatment	Velocity or pressure excitation	Distance m	No. of strokes	No. of replicates	Peak pressure level dB re 1 μPa^2	SEL dB re 1 $\mu\text{Pa}^2\text{s}$	Cumulative SEL dB re 1 $\mu\text{Pa}^2\text{s}$	Peak velocity level dB re 1 $(\text{nm/s})^2$	Velocity exposure level dB re 1 $(\text{nm/s})^2\text{s}$	Cum. velocity exposure level dB re 1 $(\text{nm/s})^2\text{s}$
control				15	0	0	0	0	0	0
sound exposure	P	200	100	15	206	182	202	142	117	137
sound exposure	P	100	100	15	211	187	207	147	122	142

2.6 Statistical analysis

The magnitude and statistical significance of the effect of the different treatments on death rates was estimated using the previously described generalised linear mixed model with random batch effects (equation 2-4 in section 2.4). However, if batch variance was estimated to be zero then a generalised linear model was used instead of assuming a random batch variance (as was done in the power analysis to avoid underestimation of the number of replicates required). In these cases, the logit transformed probability of death (p in treatment i) was modelled as a function of treatment (equation 5). The number of dead larvae (k) is binomially distributed depending on the probability of death (p) and the number of larvae at the beginning of the experiment (N) (equation 6).

$$(5) \text{ logit}(p_i) = \text{treatment}_i$$

$$(6) k_i \sim \text{Bin}(p_i, N_i)$$

The analyses were performed in SAS (glimmix procedure).

The H_0 hypothesis was: treatment has no effect. This hypothesis was tested for each trial separately at $T=5$ days and $T=10$ days (trial 1-3) or $T=7$ days (trial 4-6).

3. Results

3.1 Sound measurements

Sound pressure was measured with 4 transducers mounted in the wall of the test chamber. Particle velocity was measured by an accelerometer mounted on the piston of the sound projector (see section 2.1). Sound parameters were measured for each exposure experiment (see Appendix 5-6). The mean values per treatment and trial are presented in Tables 7 and 8.

Table 7 Expected and measured (mean by trial and treatment) peak pressure level, SEL and cumulative SEL

Trial	Distance m	No. of strokes	No. of replicates	Expected			Measured		
				Peak pressure level	SEL	Cumulative SEL	Peak pressure level	SEL	Cumulative SEL
				dB re 1 μPa^2	dB re 1 $\mu\text{Pa}^2\text{s}$	dB re 1 $\mu\text{Pa}^2\text{s}$	dB re 1 μPa^2	dB re 1 $\mu\text{Pa}^2\text{s}$	dB re 1 $\mu\text{Pa}^2\text{s}$
1	800	1	2	197	173	173	198	175	175
	100	1	2	211	187	187	211	187	187
	100	50	2	211	187	204	211	187	204
2	200	200	4	206	182	205	206	181	204
	100	50	4	211	187	204	210	186	203
	100	100	4	211	187	207	210	186	206
3	100	10	4	211	187	197	210	186	196
	200	300	5	206	182	207	205	181	206
	100	100	5	211	187	207	210	186	206
4	200	100	15	206	182	202	205	181	201
	100	100	15	211	187	207	210	186	206
5	200	100	15	206	182	202	205	180	200
	100	100	15	211	187	207	209	185	205
6	200	100	15	206	182	202	205	181	201
	100	100	15	211	187	207	209	185	205

Table 8 Expected and measured (mean by trial and treatment) peak velocity level, velocity exposure level and cumulative velocity exposure level

Trial	Distance m	No. of strokes	No. of replicates	Expected			Measured		
				Peak velocity level	Velocity exposure level	Cum. velocity exposure level	Peak velocity level	Velocity exposure level	Cum. velocity exposure level
				dB re 1 $(\text{nm/s})^2$	dB re 1 $(\text{nm/s})^2\text{s}$	dB re 1 $(\text{nm/s})^2\text{s}$	dB re 1 $(\text{nm/s})^2$	dB re 1 $(\text{nm/s})^2\text{s}$	dB re 1 $(\text{nm/s})^2\text{s}$
1	800	1	2	133	110	110	133	111	111
	100	1	3	147	124	124	148	125	125
	100	100	2	147	124	144	147	124	144
2	200	200	4	142	119	142	142	118	141
	100	100	4	147	124	144	147	122	142
3	200	300	5	142	119	144	145	122	147
	100	100	5	147	124	144	148	125	145

The measured peak pressure level and (cumulative) SEL were equal to or slightly (1-2 dB) lower than the expected values, except for the exposure representing 800 m and 1 strike. The measured peak velocity level and (cumulative) velocity exposure level differed from the expected values by -2 to +3 dB.

3.2 Initial series of experiments

Three trials were carried out during the initial series of experiments. The larvae were examined directly after the experiments (T=0) and daily until 10-12 days after the experiment (T=10-12). No immediate visible effects (T=0) were observed in any of the trials.

In trial 1 (stage 1 larvae), mean cumulative mortality rate increased from 0-4% at T=0 to 46-82% at T=12 (Figure 12). Although differences between treatments appeared to occur, these differences were not significant (Table 9) and no clear effect of exposure was observed (Figures 12 and 13). High batch variance (variability between batches with the same treatment) was observed (Table 9 and Figure 13). Hence, 2 replicates per treatment was insufficient to detect an effect of exposure, unless the magnitude of the effect is much larger than the batch variance.

In trial 2 (stage 2 larvae), 4 (in 1 case 5) replicate experiments were carried out for each treatment. Mean cumulative mortality rate increased from 0% at T=0 to 53-80% at T=10 (Figure 12). The highest pressure exposure (corresponding to a distance of 100m and 100 strikes) appeared to be associated with higher mortality after 5-10 days (Figure 12). A cumulative mortality rate of 80% was observed for this exposure after 10 days, compared to 57-61% in the 2 control groups (Figures 12 and 13). If significant, a difference of this magnitude, i.e. 50% of the larvae which survive 'natural mortality' are killed due to noise, would be considered to be biologically relevant. The difference, however, was not statistically significant (Table 9). A larger number of replicates is necessary to be able to assess the statistical significance of a difference of this magnitude, given the large batch variance.

In trial 3 (stage 3-4a larvae), 5 (in 1 case 4) replicate experiments were carried out for each treatment. Mean cumulative mortality rate increased from 0% at T=0 to 8-13% at T=12 (Figure 12). No clear effect of exposure was observed (Figures 12 and 13), and the differences between treatments were statistically insignificant (Table 9).

The power analyses showed that, with 5 replicates and 25 larvae per batch, the probability of statistically detecting an effect of the magnitude as observed in trial 2 is low (8-60%, see section 2.4). This means that an effect of this magnitude cannot be excluded in any of the 3 trials.

Table 9 Statistical test of the significance of treatment in trial 1-3. The models are described in sections 2.4 and 2.6

Trial	Nr. of treatments	Nr. of batches	Nr. of larvae	T	Chi ² /DF	Variance random effect	Type III tests of fixed effects			
							Num DF	Den DF	F value	Pr > F
1	8	17	420	5	0.66	0	7	9	0.35	0.9
				10	1.01	1.8228	7	8.76	0.37	0.9
2	7	29	791	5	1.02	0.3976	6	21.17	1.15	0.4
				10	1.07	0.8398	6	19.13	0.72	0.6
3	7	34	1000	5	1.09	0.0143	6	25.79	0.78	0.6
				10	1.05	0	6	27	0.34	0.9

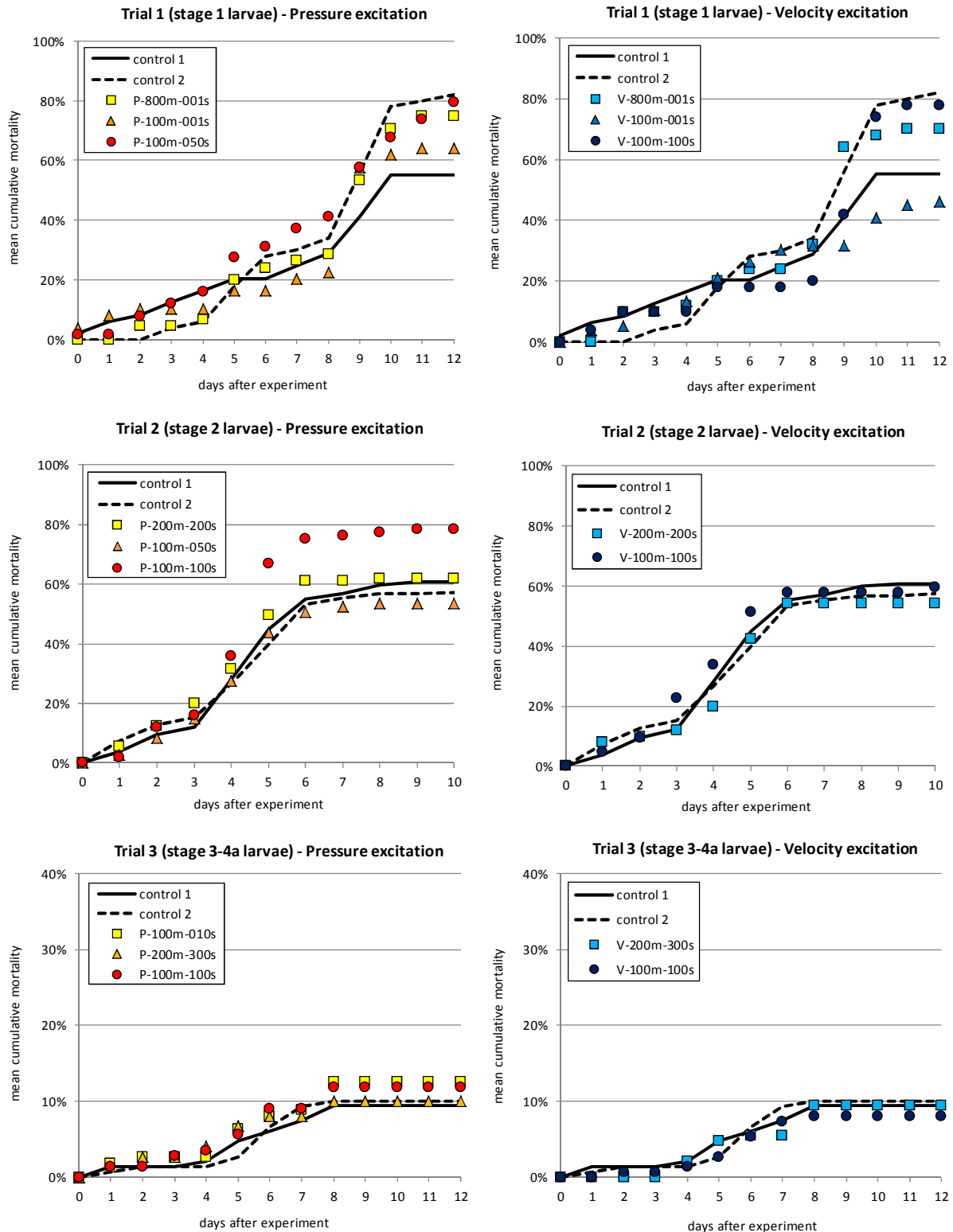

Figure 12 Trial 1-3. Mean cumulative mortality rate in the days after the experiments for pressure excitation exposures (left), velocity excitation exposures (right) and control groups. The labels of the exposures refer to pressure or velocity excitation (P or V), the distance from a typical piling site (e.g. 100m) and the number of strikes (e.g. 100s). The sound parameters for these exposures are presented in Tables 7-8

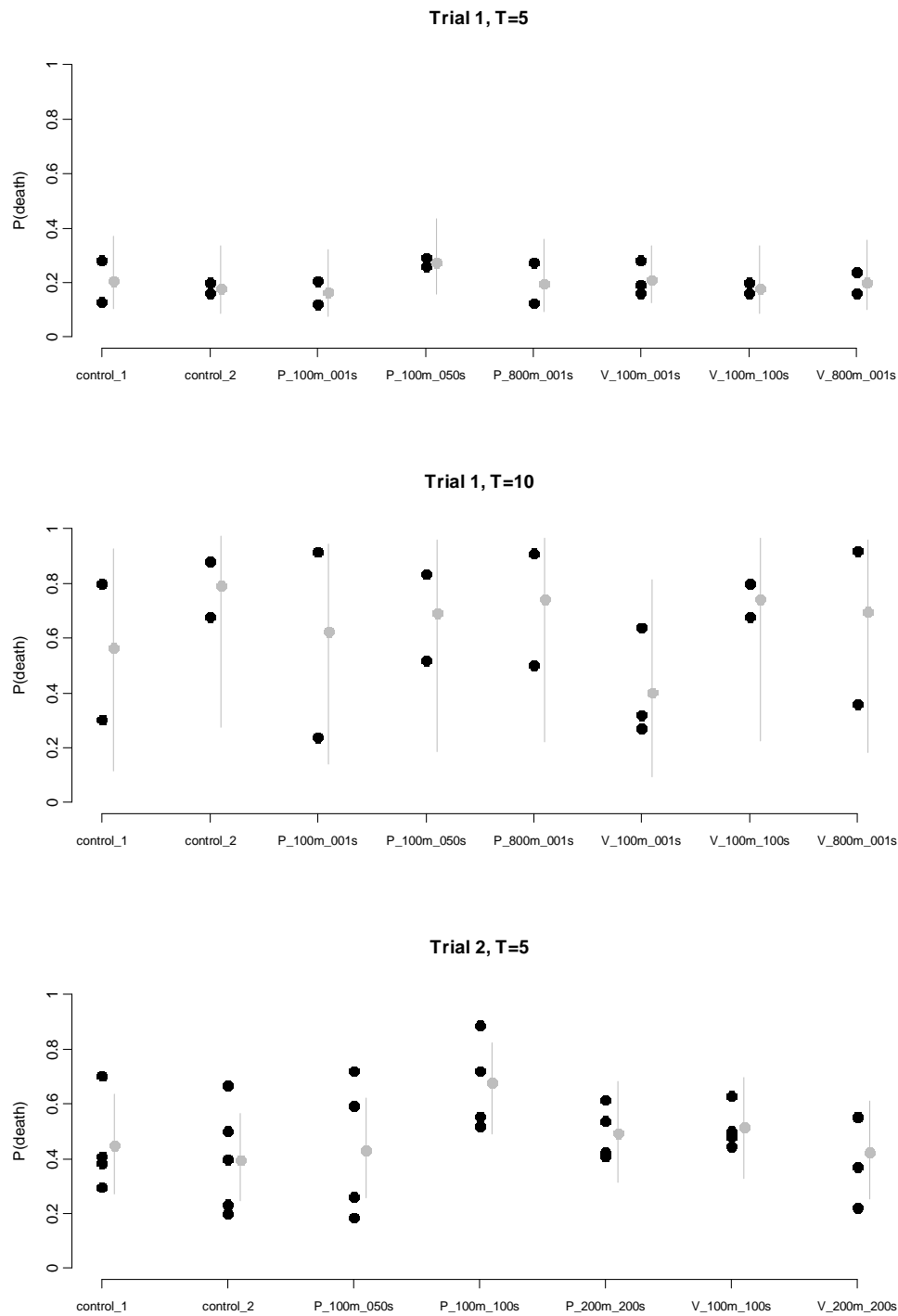

Figure 13 Trial 1-3. Estimated mean probability of death with 95% confidence limits (grey) and observed mortality rates for each replicate within each treatment (black), at T=5 days and T=10 days. Each replicate consisted of 23-30 larvae

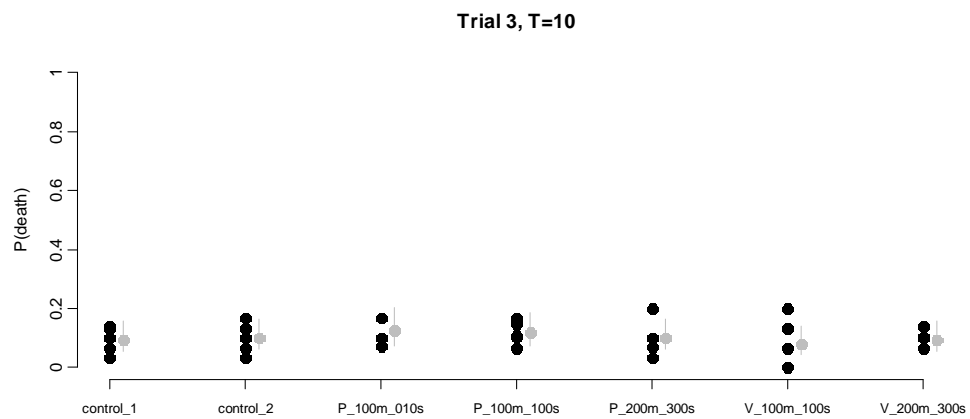
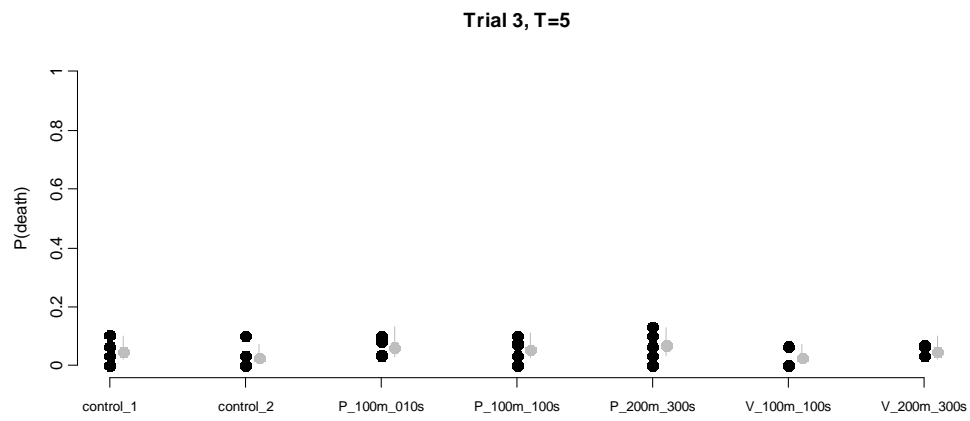
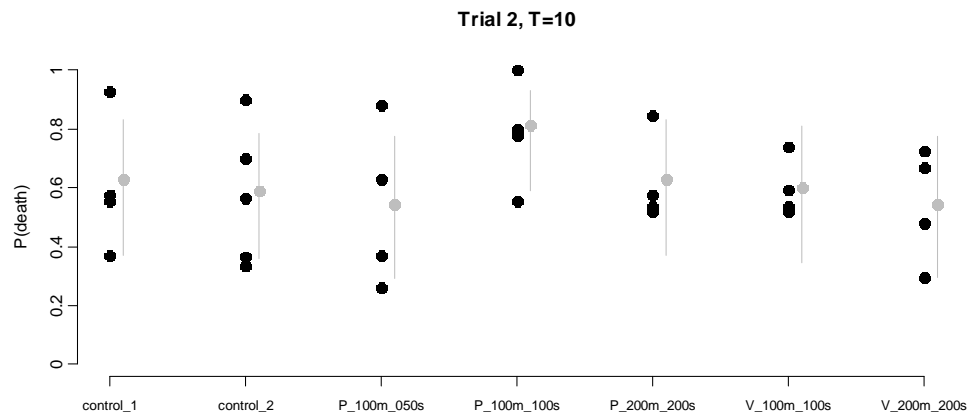

Figure 13 Continued

3.3 Second series of experiments

Three trials were carried out during the second series of experiments. Stage 1 larvae were used in trial 4, stage 2 larvae in trial 5 and stage 3-4a larvae in trial 6. The number of replicates per treatment was increased to 15, according to the results of the power analysis (see section 2.4). The number of treatments possible per trial was 3 (2 exposures and 1 control group). The exposures were limited to high level pressure excitation exposures (Table 7). The larvae were examined directly after the experiments (T=0) and daily until 7 days after the experiment (T=7).

Mortality rates in the first 7 days after the experiments were lower in trial 4 than trial 1 (stage 1 larvae), lower in trial 5 than trial 2 (stage 2 larvae), and higher in trial 6 than in trial 3 (stage 3-4a larvae). The variance between batches was generally lower in the second series of experiments compared to the first series of experiments.

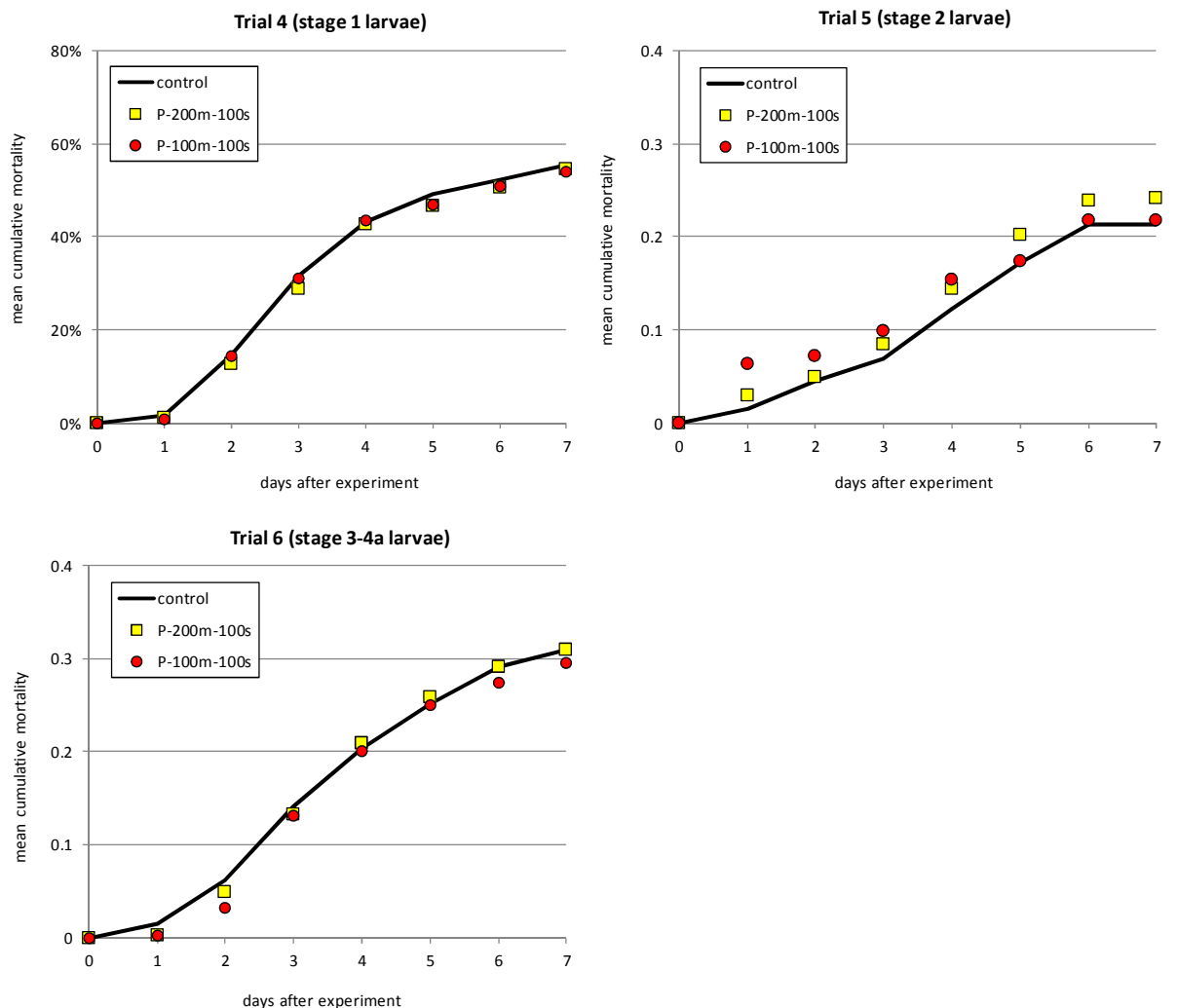

Figure 14 Trial 4-6. Mean cumulative mortality rate in the days after the experiments for pressure excitation exposures and the control group. The labels of the exposures refer to pressure excitation (P), the distance from a typical piling site (100m or 200m) and the number of strikes (100s). The sound parameters for these exposures are presented in Table 7

No immediate visible effects were observed in any of the trials. Only in trial 5 a small effect of exposure appeared to occur in the days after the experiment (Figure 14), but the factor treatment was statistically insignificant in all trials (Table 10, Figure 15).

Model estimates of the mean and variance of each treatment and of the difference of each exposure group with the control group are presented in Table 11. Mean and maximum % effect were calculated (equation 1 in section 2.4) based on the estimated mean and upper limit of 95% confidence interval for the difference between exposure and control. The probability of an effect larger than the maximum % effect is small (<5%). The maximum % effect values ranged from 8 to 14%.

Table 10 Statistical test of the significance of treatment in trial 4-6. The models are described in sections 2.4 and 2.6

Trial	Nr. of treatments	Nr. of batches	Nr. of larvae	T	Chi ² /DF	Variance random effect	Type III tests of fixed effects			
							Num DF	Den DF	F value	Pr > F
4	3	45	1118	5	0.82	0	2	42	0.31	0.7
				7	0.68	0	2	42	0.09	0.9
5	3	45	1102	5	1.00	0.1404	2	41.90	0.48	0.6
				7	1.00	0.0568	2	41.67	0.40	0.7
6	3	45	1109	5	0.99	0.0340	2	42	0.03	0.9
				7	0.99	0	2	42	0.10	0.9

Table 11 Model estimates of the mean and variance of each treatment (on logit and probability scale), model estimates of the difference of each exposure group with the control group (mean and upper limit of the 95% confidence interval on logit scale), and the mean and maximum effect (as % change in probability of death compared to the control group) calculated using the mean and upper limit estimates of the difference with the control group

Trial	T	Treatment	Estimates (logit scale)		Estimated probability of death			Difference with control (logit scale)		Effect (%)	
			mean	standard error	mean	lower limit 95% c.i.	upper limit 95% c.i.	mean	upper limit 95% c.i.	mean	maximum
4	5	P-100m-100s	-0.1146	0.1046	0.47	0.42	0.52	-0.0774	0.2188	-4%	11%
		P-200m-100s	-0.1500	0.1037	0.46	0.41	0.51	-0.1129	0.1821	-6%	9%
		control	-0.0371	0.1030	0.49	0.44	0.54				
4	7	P-100m-100s	0.1584	0.1047	0.54	0.49	0.59	-0.0600	0.2373	-3%	13%
		P-200m-100s	0.1715	0.1038	0.54	0.49	0.59	-0.0468	0.2492	-3%	14%
		control	0.2184	0.1036	0.55	0.50	0.61				
5	5	P-100m-100s	-1.5713	0.1699	0.17	0.13	0.23	0.0124	0.4948	0%	10%
		P-200m-100s	-1.3788	0.1629	0.20	0.15	0.26	0.2048	0.6778	4%	14%
		control	-1.5837	0.1682	0.17	0.13	0.22				
5	7	P-100m-100s	-1.2787	0.1415	0.22	0.17	0.27	0.0342	0.4365	1%	10%
		P-200m-100s	-1.1463	0.1372	0.24	0.19	0.30	0.1666	0.5632	4%	14%
		control	-1.3128	0.1405	0.21	0.17	0.26				
6	5	P-100m-100s	-1.1032	0.1301	0.25	0.20	0.30	-0.0067	0.3622	0%	10%
		P-200m-100s	-1.0598	0.1283	0.26	0.21	0.31	0.0367	0.4030	1%	11%
		control	-1.0965	0.1284	0.25	0.21	0.30				
6	7	P-100m-100s	-0.8669	0.1147	0.30	0.25	0.35	-0.0637	0.2594	-2%	8%
		P-200m-100s	-0.8051	0.1127	0.31	0.26	0.36	-0.0018	0.3184	0%	10%
		control	-0.8032	0.1117	0.31	0.26	0.36				

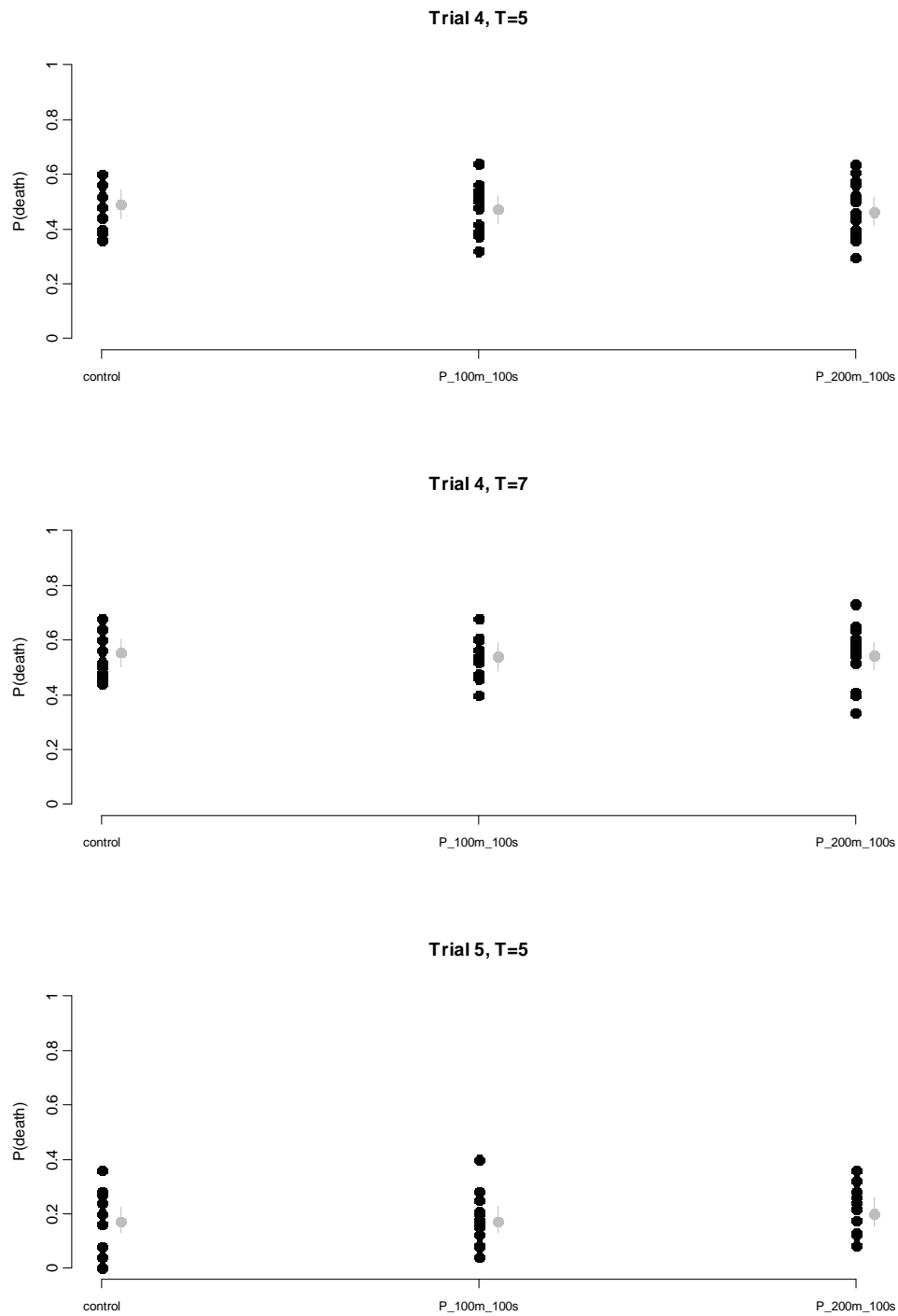
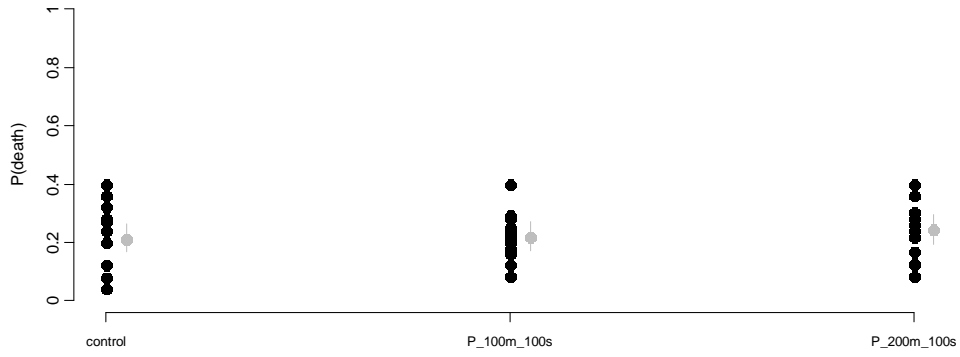
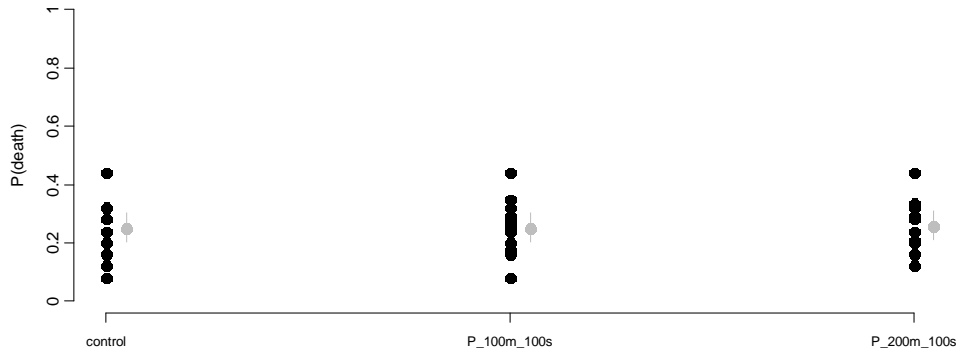

Figure 15 Trial 4-6. Estimated mean probability of death with 95% confidence limits (grey) and observed mortality rates for each replicate within each treatment (black), at T=5 days and T=7 days. Each replicate consisted of 23-27 larvae

Trial 5, T=7



Trial 6, T=5



Trial 6, T=7

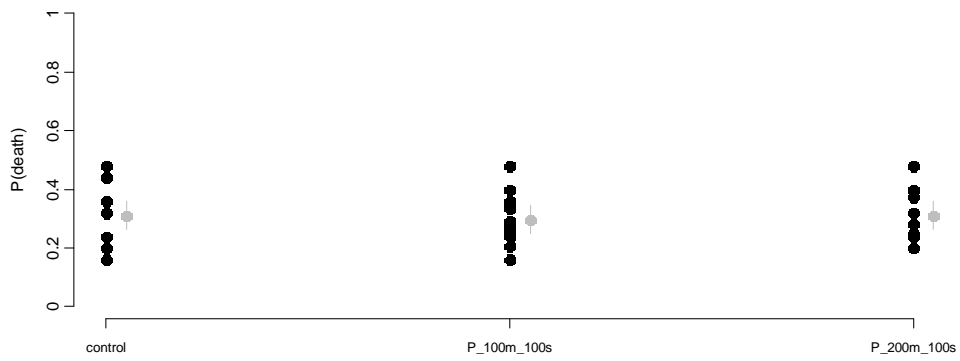

Figure 15 Continued

4. Discussion

4.1 General discussion

We did not find evidence that the survival of common sole larvae depends on the different levels of exposure to piling noise that were used in this study. No statistically significant differences in mean mortality rates were found between the control and exposure groups for any of the larval stages (Table 9 and 10). In the initial series of experiments, the absence of statistically significant effects of sound exposure could have been caused by low statistical power due to small effective sample sizes (low numbers of batches in the presence of large batch effects). However, in the second series of experiments, the number of replicates (batches) per treatment was increased substantially. Standard errors on estimated death rates were such that an exposure effect of more than 14% could be excluded at the 95% confidence level (Table 11).

For the larvae that were not exposed to sound (the control groups), mean cumulative mortality after 7 days ranged from 10 to 60% (Figures 12 and 14). These levels are not high compared to natural mortality. In most marine fish species, natural mortality rates are much higher during the egg and larval stages than in the juvenile and adult stages. Instantaneous mortality rates of common sole eggs in the field were estimated at 0.4 to 0.6 d⁻¹ (i.e. 94-99% mortality after 7 days) by van der Land (1991). No published estimates of natural mortality are available for common sole larvae, but estimates for plaice larvae range between 0.05 d⁻¹ (Beverton & Iles 1992, Zijlstra 1982) and 0.08 d⁻¹ (Harding & Talbot 1973), that is 30-43% mortality after 7 days. Similar or higher larval mortality rates (up to 0.7 d⁻¹) were estimated for other marine fish species (McGurk 1986). The differences in control group mortality between trials were not only related to larval stage, but also to the quality of the batch of eggs. Clear differences were observed in the viability of eggs and larvae obtained from different spawning events (pers. com. J. van der Heul, SOLEA BV). This was also reported by Palazzi et al. (2006). Their mortality rates for hatchery reared common sole larvae ranged from 35 to 80%, depending on the spawning group.

The interim cumulative SEL criterion defined by the US Fisheries Hydro-acoustic Working Group (FHWG) for non-auditory tissue damage in fish <2 gram is 183 dB (Oestman et al. 2009). The highest cumulative SEL used in the present study (206 dB) was much higher than this norm, but no significant effects on the survival of common sole larvae were observed. Initially, the FHWG proposed single-strike thresholds at 187 dB SEL and 208 dB peak pressure for the onset of injury from pile driving (Popper et al. 2006), based on an evaluation of the available information (Hastings & Popper 2005). Later these criteria were updated: the SEL norm of 187 dB was proposed for cumulative SEL instead of single-stroke SEL (Woodbury & Stadler 2008), the SEL norm was reduced to 183 dB for small fish (Hastings 2007, Stadler & Woodbury 2009), and the peak pressure norm was reduced to 206 dB (Carlson et al. 2007, Stadler & Woodbury 2009). Stadler and Woodbury (2009) state that these thresholds represent the initial onset of injury, not the levels at which fishes will be severely injured or killed. Nevertheless, these levels were opposed to by several members of the FHWG (pers. com. Prof. Arthur Popper).

Very little is known on the sound levels that cause damage or mortality in fish eggs and larvae. No studies have addressed the effect of piling noise on fish larvae, but there are a few studies which investigate the effect of loud impulse noises on fish larvae (see the reviews by Dalen et al. 2007 and Popper & Hastings 2009). Booman et al. (1996) examined the effect of seismic air guns on eggs and different larval stages of cod (*Gadus morhua*), saithe (*Pollachius virens*), herring (*Clupea harengus*), turbot (*Psetta maximus*) and plaice (*Pleuronectes platessa*) in field experiments. Effect was related to the distance from the sound source and the corresponding peak sound pressure levels, 220 to 242 dB re 1 µPa² (which is much higher than the peak pressure levels used in the present study). Cod, turbot and

herring were examined in the yolk sac stage (larval stage 1 according to the classification used in the present study): cod showed a small but insignificant effect at 242 dB peak level, herring showed no significant effects due to overall high mortality rates, and turbot showed significant effects at all levels of exposure. Cod and saithe were examined in the post yolk sac larval stages: significant effects were observed for cod at 223 dB, no significant effects were observed for saithe due to overall high mortality rates. Cod, turbot, herring and plaice were examined in the post-larval stage (not included in the present study): cod showed a significant effect at 242 dB, small but insignificant effects were observed at the higher exposure levels for the other 3 species. The authors also reported damage to the neuromasts of the lateral line system and to other organs in cod and turbot larvae.

Govoni et al. (2008) exposed larval and small juvenile spot (*Leiostomus xanthurus*) and pinfish (*Lagodon rhomboides*) to blast shock waves in field experiments. Effect was related to the distance from the sound source and several sound parameters were measured. The size of the test animals was 18-20 mm for spot and 16-17 mm for pinfish (note that these larvae/juveniles were larger than the larvae used in the present study). The authors recorded death, lethal and sub-lethal injuries. For spot, the proportion dead or injured was 0% in the control group and 100% at the highest exposure level: peak pressure=278-692 kPa (\sim peak pressure level = 229-236 dB re 1 μPa^2) and energy flux density=1.096-3.642 J m^{-2} (\sim SEL = 182-187 dB re 1 $\mu\text{Pa}^2\text{s}$ assuming the impedance of the medium to be $1.53 \cdot 10^6 \text{ kg/m}^2\text{s}$). For pinfish, the proportion dead or injured was 0% in the control group and ranged from 33-100% at the highest exposure level: peak pressure=558-866 kPa (\sim peak pressure level = 235-239 dB re 1 μPa^2) and energy flux density= 1.311-2.594 J m^{-2} (\sim SEL = 183-186 dB re 1 $\mu\text{Pa}^2\text{s}$). The blasts applied in Govoni et al. (2008) apparently had a different signal shape compared to our simulations of piling noise; their highest exposures had much higher peak pressure levels than in our study, whereas the single-strike SELs were comparable.

These two studies suggest that exposure to loud impulse sounds can cause lethal and sub-lethal effects in fish larvae. The peak pressure levels applied in these two studies were much higher than in the present study. Single-stroke SEL was only reported in one of the two studies (Govoni et al. 2008) and their highest levels (182-187 dB) were comparable to range we used in the second series of experiments (181-186 dB, Table 7). Comparison of our results with those of Govoni et al. (2008) indicates that either peak pressure may be the driving factor causing mortality, or common sole larvae are less vulnerable to sound exposure than pinfish and spot larvae/small juveniles.

Common sole larvae only have a swim bladder during a limited period of their larval life (Boulhic & Gabaudan 1992, Palazzi et al. 2006). The swim bladder is an organ which is sensitive to sound pressure and it has been suggested that fish with swim bladders are more vulnerable to sound exposure than species that do not have such air chambers (see review in Popper & Hastings 2009). The effect of sound pressure during the larval stage may be less for species in which the swim bladder is resorbed at end of the larval stage. However, if the presence/absence of a swim bladder is critical at the exposure levels used in this study, then an effect would have been observed in trial 6, as most larvae used in this trial had a swim bladder (stage 3-4a larvae, see section 2.2). Furthermore, Boomans et al. (1996) observed significant effects of sound on the survival of turbot larvae and the appearance and disappearance of the swim bladder in turbot larvae is very similar to common sole larvae (Al-Maghazachi & Gibson 1984).

Statistically significant lethal effects of exposure to pile driving noise in common sole larvae probably occur at higher sound levels than the highest levels used in the present study (cumulative SEL = 206 dB re 1 $\mu\text{Pa}^2\text{s}$, peak pressure = 210 dB re 1 μPa^2). The limited information available to date indicates that interspecific differences in vulnerability to sound exposure may occur. Hence, we would not recommend that the conclusion based on common sole, be broadly extrapolated to other fish larvae. However, this study does indicate that the previous assumptions and criteria may need to be revised.

Our findings are corroborated by recent work by Brandon Casper and co-authors, presented at the Meeting of the Acoustical Society of America in Seattle in May 2011, which also indicates that the US interim criteria are probably too low (pers. com. Prof Arthur Popper). They examined injuries and recovery from injuries in juvenile Chinook salmon, which were exposed to pile driving noise using an experimental device, the HICI-FT (Martin & Rogers 2008) on which our larvaebrator was inspired.

A statistically significant effect of sound exposure in experiments does not necessarily indicate a 'biological significant' effect at the population level. For fish larvae, the significance of an effect at the population level depends on the distance from the sound source at which the critical sound level is exceeded, the spatial and temporal distribution of fish larvae (by species), and the hydrodynamic transport patterns of fish larvae. If dose-effect relationships for sound exposure are available then the effects at the population level can be assessed using an updated version of the larval transport model (Bolle et al. 2009).

The present study only focussed on potential lethal effects of sound exposure. The exposures may have caused damage to body tissues or hearing, or may have affected physiology (e.g. growth rates), which did not lead to death within the monitoring period, but may result in lower survival on the long-term. Sound exposure may also affect behaviour and hence predation and starvation risks. Although behaviour was not recorded during this study, we had the impression that larvae exposed to high sound pressure levels were 'stunned' after the experiment; they exhibited less swimming activity compared to the other larvae. They appeared to recover quickly, no behavioural differences were observed a few hours after the experiment.

4.2 Management implications

The highest sound exposure used in this study represented 100 strikes at a distance of 100m from a 'typical' North Sea piling site. Note that sound generation and propagation depend on several factors (e.g. diameter pile, water depth). The specification of a 'typical' North Sea piling site is described in section 2.1. The peak pressure and single-pulse SEL to which a larva is exposed depends on the distance from a piling site. The number of pulses and hence the cumulative SEL a larva is exposed to depend on the frequency of piling strikes and the speed at which larvae are transported by water currents.

It is still uncertain which acoustic exposure metric correlates with mortality of larvae. If peak sound pressure level or single-pulse SEL is the most important sound parameter determining larval survival, then it can be concluded that the sound threshold for an effect $\geq 14\%$ in common sole corresponds to a distance of $< 100\text{m}$ from a 'typical' North Sea piling site. If cumulative SEL is the driving factor, then the conversion to distance is more complicated. The highest cumulative SEL applied in this study (206 dB) corresponds to 100 strikes at a distance of 100 m, but also to e.g. 2500 strikes at a distance of 1000 m from a 'typical' North Sea piling site (Figure 16, red line). This relationship has an (unknown) upper limit for distance; single-strike SELs below a certain level will not contribute to the overall cumulative SEL, because it has no effect on a fish (Stadler & Woodbury 2009). Realistic estimates for piling frequency and average water current in the North Sea are 1 strike per 1.5 second and 0.5 m/s. Given these estimates, the distance drifted will exceed the distance to the piling site in combinations with more than 500 strikes (Figure 16, blue line). This means that, on average, a cumulative SEL exposure ≥ 206 dB will be unlikely at a distance $\geq 400\text{m}$.

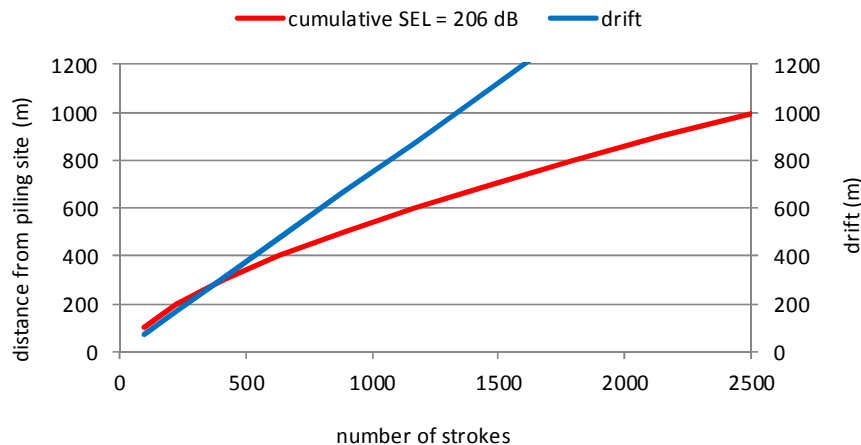

Figure 16 Combinations of distance from a 'typical' North Sea piling site and number of strikes, which correspond to a cumulative SEL of 206 dB re $1 \mu\text{Pa}^2\text{s}$ (red line). Estimated drift assuming 1 piling strike per 1.5 s and an average current of 0.5 m/s (blue line)

The assumption of 100% mortality within a radius of 1000 m around a piling site used in the Appropriate Assessment of Dutch offshore wind farms (Prins et al. 2009), appears to be too conservative in the case of common sole larvae. This study showed that the threshold for lethal effects $\geq 14\%$ in common sole larvae is at a distance of less than 400 m from a 'typical' North Sea piling site. An estimation of the radius in which a small effect ($< 14\%$) may occur cannot be supported statistically, but the absence of effects in the second series of experiments indicated that mortality of common sole larvae at a large distance from the piling site is highly unlikely. For this species, a prudent adaption of the assumption would be 100% larval mortality up to a distance of 400 m and 14% mortality at a distance of 400-1000 m from a 'typical' North Sea piling site. This adapted assumption would lead to a reduction of $\pm 50\%$ of the effects estimated by Prins et al. (2009) for common sole.

The most important question which needs to be addressed before any management measures are revised is: are these results for common sole representative for effects on larvae of other fish species?

4.3 Future research

Other species

The first logical step in future research is to examine the effects of sound exposure on larvae of other fish species using the 'larvaebrator.' Is the absence of effects in common sole larvae, at the sound exposure levels used in the present study, representative for other fish species? The limited literature available suggests interspecific differences in the larval stage may occur, but this may also be a sample size or methodological issue. It is important to note that the number of species which can be obtained from commercial hatcheries is limited. Hence, laboratory rearing may be required.

It is recognised that using hatchery or laboratory reared larvae may influence the results of sound exposure experiments. Differences in behavioural responses to acoustic predator stimuli were observed between hatchery reared and wild cod (Meager et al. 2011). Although Wysocki et al. (2007) did not detect effects of aquaculture production noise on hearing in rainbow trout, they did find variation in hearing depending on how long the eggs had been kept before they were allowed to develop. Hatchery rearing may also cause malformations in swim bladder development (e.g. Trotter et al. 2001). However, in the case of fish larvae, there is no alternative to using hatchery or laboratory reared larvae. It is impossible to catch live larvae in sufficient numbers.

Sound parameters and co-variables

Another important step is to examine the role of different sound parameters and co-variables in more detail. Major advantage of laboratory experiments compared to field experiments is that variables can be controlled, allowing investigation of the critical variables and processes causing mortality.

Our experimental set-up was designed to enable sound exposures representative of piling noise which exceeded the thresholds of the US FHWG interim criteria. However, it now appears that these criteria may be too low (see section 4.1) and higher exposures may be required to cause damage in fish larvae. Higher exposures with a signal representative for pile driving are not possible using our larvaebator, but we could explore the effects of increased (single-strike and cumulative) SEL by changing the signal shape.

It is still uncertain which acoustic exposure metric correlates with injury and mortality. While the available literature suggests that peak pressure and cumulative SEL are the driving factors, other metrics, such as kurtosis, may be better predictors of (sub-)lethal effects. The interpretation of the significance of an effect at the population level depends on which sound parameters are causing effects. Further examination of the effects of particle velocity is also considered to be relevant, because velocity metrics have received little attention so far.

Static pressure may influence the effects of sound pressure exposures (presentation by Tom Carlson at the symposium 'Effects of noise on aquatic life', August 2010). This was taken into consideration during the development of the larvaebator, but (in the end) no experiments were carried to examine the effect of this co-variable during the present study. If significant sound effects are observed in future experiments, then the role of static pressure needs to be examined. If static pressure (i.e. water depth) plays an important role, then this will have consequences for the interpretation of the significance of a sound effect at the population level.

Response variables

The present study was limited to lethal effects. The exposures may have caused other effects that did not show up in mortality during a monitoring period of 7-12 days, but which may have profound effects on fitness and survival on the long-term.

Injuries can be examined using preserved larvae. In the present study, we preserved all live larvae at the end of the monitoring period for future examination (see section 2.2). For future experiments it is recommended to preserve larvae directly after the experiment and at regular intervals during the monitoring period, as recovery from injuries may occur (presentation by Brandon Casper at the Meeting of the Acoustical Society of America in Seattle in May 2011).

Exposure to piling noise as a larva may have effects on physiology or behaviour at a later stage in live, such as reduced hearing, reduced growth or differential behaviour. To be able to examine effects like this it will be necessary to maintain the animals used in the experiment for a substantial time after the experiment.

Field experiments

At a later stage it will be necessary to confirm the results of laboratory experiments during field experiments. We recommend to first continue laboratory experiments before undertaking field experiments, as insights obtained from laboratory experiments will greatly facilitate field experiments.

Caged larvae will be exposed to real piling noise at different distances from a piling operation. Actual sound exposure during the piling sessions will be measured. We propose to examine effects on mortality, growth and tissue damage at different times after the exposure.

Population level effects

When more knowledge on critical parameters and processes has been obtained, and after dose-effect relationships have been quantified, it will be necessary to model the effects at the population level. This will require further development of the larval transport model.

5. Quality Assurance

A previous version of this report has been reviewed by 3 external reviewers (Prof. Arthur N. Popper, Prof. Audrey J. Geffen and Rick Wortelboer). Their suggestions for improvement of the document have been adopted.

IMARES utilises an ISO 9001:2008 certified quality management system (certificate number: 57846-2009-AQ-NLD-RvA). This certificate is valid until 15 December 2012. The organisation has been certified since 27 February 2001. The certification was issued by DNV Certification B.V. Furthermore, the chemical laboratory of the Environmental Division has NEN-AND-ISO/IEC 17025:2005 accreditation for test laboratories with number L097. This accreditation is valid until 27 March 2013 and was first issued on 27 March 1997. Accreditation was granted by the Council for Accreditation.

References

- Ainslie MA, de Jong CAF, Dol HS, Blacquière G, Marasini C (2009) Assessment of natural and anthropogenic sound sources and acoustic propagation in the North Sea. TNO report 2009 - C085
- Ainslie MA (2011) Standards for measurement of underwater sound, Part I: physical quantities and their units. report TNO report 2011 - # (in prep)
- Al-Maghazachi SJ, Gibson R (1984) The developmental stages of turbot, *Scophthalmus maximus*. Journal of Experimental Marine Biology and Ecology 82:35-51
- Amara R, Lagardère F, Desaunay Y (1993) Seasonal distribution and duration of planktonic stage of Dover sole, *Solea solea*, larvae in the Bay of Biscay; an hypothesis. Journal of Fish Biology 43 17-30
- Arbault S, Camus P, Le Bec C (1986) Estimation of the common sole (*Solea vulgaris* Quensel 1806) spawning stock by egg survey in the Bay of Biscay. J Appl Ichthol 4:145-156
- Beverton RJH, Iles, T.C. (1992) Mortality rates of 0-group plaice (*Pleuronectes platessa* L.), dab (*Limanda limanda* L.) and turbot (*Scophthalmus maximus* L.) in European waters II. Comparison of mortality rates and construction of life table for 0-group plaice. Neth J Sea Res 29:49-59
- Booman C, Dalen J, Leivestad H, Levsen A, van der Meeren T, Toklum K (1996) Effekter av luftkanonskyting på egg, larver og yngel. Undersøkelser ved Havforskningsinstituttet og Zoologisk Laboratorium UIB, Fisken og Havet. Havforskningsinstituttet, Bergen
- Bolle LJ, Dickey-Collas M, Erftemeijer PLA, van Beek JKL, Jansen HM, Asjes J, Rijnsdorp AD, Los HJ (2005) Transport of fish larvae in the southern North Sea. Impacts of Maasvlakte 2 on the Wadden Sea and North Sea coastal zone (track 1, part IV: fish larvae) & baseline study MEP Maasvlakte 2 (lot3b: fish larvae). RIVO Report C072/05
- Bolle LJ, Dickey-Collas M, van Beek JKL, Erftemeijer PLA, Witte JIJ, van der Veer HW, Rijnsdorp AD (2009) Variability in transport of fish eggs and larvae. III. Effects of hydrodynamics and larval behaviour on recruitment in plaice. Marine Ecology Progress Series 390:195-211
- Bolle LJ, Rijnsdorp AD and others (in prep) Spawning grounds of common sole (*Solea solea*) in the North Atlantic. ICES Journal of Marine Science
- Boulhic M, Gabaudan J (1992) Histological Study of the Organogenesis of the Digestive-System and Swim Bladder of the Dover Sole, *Solea solea* (Linnaeus 1758). Aquaculture 102:373-396
- Boulhic M, Galois R, Koutsikopoulos C, Lagardère F, Person-Le Ruyet J (1992) Nutritional status, growth and survival of the pelagic stages of Dover sole *Solea solea* (L.) in the Bay of Biscay. Ann Inst océanogr 68:117-139
- Bos OG, Leopold MF, Bolle LJ (2009) Passende Beoordeling windparken: Effecten van heien op vislarven, vogels en zeezoogdieren. IMARES rapport C079/09
- Carlson T, Hastings M, Popper AN (2007). Update on Recommendations for revised interim sound exposure criteria for fish during pile driving activities. Memorandum to the California Department of Transportation. www.dot.ca.gov/hq/env/bio/files/ct-arlington_memo_12-21-07.pdf

- Champalbert G, Koutsikopoulos C (1995) Behaviour, transport and recruitment of Bay of Biscay sole (*Solea solea*): laboratory and field studies. *J mar biol Ass UK* 75:93-108
- Conway DVP, Coombs SH, Smith C (1997) Vertical distribution of fish eggs and larvae in the Irish Sea and southern North Sea. *ICES Journal of Marine Science* 54:136-147
- de Jong CAF, Ainslie MA (2008) Analysis of the underwater sound during piling activities for the Off-shore Wind Park Q7, Delft: TNO report MON-RPT-033-DTS-2007-03388
- Dalen J, Dragsund E, Næss A, Sand O (2007) Effects of seismic surveys on fish, fish catches and sea mammals, DNV Energy. Report for the Cooperation group - Fishery Industry and Petroleum Industry. Report no. 2007-0512.
- Dickey-Collas M, Bolle LJ, van Beek JKL, Erftemeijer PLA (2009). Variability in transport of fish eggs and larvae. II. Effects of hydrodynamics on the transport of Downs herring larvae. *Marine Ecology Progress Series* 390:183-194
- Erftemeijer PLA, van Beek JKL, Bolle LJ, Dickey-Collas M, Los HFJ (2009). Variability in transport of fish eggs and larvae. I. Modelling the effects of coastal reclamation. *Marine Ecology Progress Series* 390:167-181
- Fonds M (1979) Laboratory observations on the influence of temperature and salinity on development of the eggs and growth of the larvae of *Solea solea* (Pisces). *Marine Ecology Progress Series* 1:91-99
- Govoni JJ, West MA, Settle LR, Lynch RT, Greene MD (2008) Effects of underwater explosions on larval fish: Implications for a coastal engineering project. *Journal of Coastal Research* 24:228-233
- Grioche A, Harlay X, Koubbi P, Lago LF (2000) Vertical migrations of fish larvae: Eulerian and Lagrangian observations in the Eastern English Channel. *Journal of Plankton Research* 22:1813-1828
- Harding D, Talbot JW (1973) Recent studies on the eggs and larvae of plaice (*Pleuronectes platessa* L.) in the Southern Bight. *Rapp P -v Réun Cons int Explor Mer* 164:261-269
- Hastings MC & Popper AN (2005). Effects of sound on fish. Report prepared for California Department of Transportation. www.dot.ca.gov/hq/env/bio/files/Effects_of_Sound_on_Fish23Aug05.pdf
- Hastings MC (2007) Calculation of SEL for Govoni et al. (2003, 2007) and Popper et al. (2007) studies. Report for Amendment to Project 15218, J&S Working Group. www.dot.ca.gov/hq/env/bio/files/Rprt_SEL_dta_analysis_govoni_popper.pdf
- Houghton RG, Riley JD (1981) Sole (*Solea solea*) spawning areas. In Lee AJ, Ramster JW (Eds) *Atlas of the seas around the British Isles*, MAFF, London.
- Koutsikopoulos C, Fortier L, Gagne JA (1991) Cross shelf dispersion of Dover sole (*Solea solea*) eggs and larvae in Biscay Bay and recruitment to inshore nurseries. *Journal of Plankton Research* 13:923-945
- Koutsikopoulos C, Lacroix N (1992) Distribution and abundance of sole (*Solea solea* (L.)) eggs and larvae in the Bay of Biscay between 1986 and 1989. *Netherlands Journal of Sea Research* 29:81-91

Lagardère F, Amara R, Joassard L (1999) Vertical distribution and feeding activity of metamorphosing sole, *Solea solea*, before immigration to the Bay of Vilaine nursery (northern Bay of Biscay, France). *Environmental Biology of Fishes* 56:213-228

Lewis TN, Rogers PH, Martin JS, McCall GS, Lloyd JG, Cotton HP, Caille GW (1998) Test chamber for determining damage thresholds for high-amplitude underwater sound exposure in animal models (A), *Journal of the Acoustical Society of America* 103(5), 2756

MacGillivray A, Racca R (2005) Sound pressure and particle velocity measurements from marine pile driving at Eagle Harbor maintenance facility, Bainbridge Island WA, Victoria, BC, Canada: JASCO Research Ltd. report for Washington State Department of Transportation

Martin JS, Rogers PH (2008) Sound exposure chamber for assessing the effects of high-intensity sound on fish. *Bioacoustics* 17:331-333

McGurk MD (1986) Natural mortality of marine pelagic fish eggs and larvae - Role of spatial patchiness. *Marine Ecology Progress Series* 34:227-242

Meager JJ, Rodewald P, Domenici P, Ferno A, Jarvi T, Skjaeraasen JE, Sverdrup GK (2011) Behavioural responses of hatchery-reared and wild cod *Gadus morhua* to mechano-acoustic predator signals. *Journal of Fish Biology* 78:1437-1450

Nehls G, Betke K, Eckelmann S, Ros M (2007) Assessment and costs of potential engineering solutions for the mitigation of the impacts of underwater noise arising from the construction of offshore wind farms, COWRIE report ENG-01-2007 (www.offshorewindfarms.co.uk/Assets/COWRIE-ENGFinal270907.pdf)

Oestman R, Buehler D, Reyff JA, Rodkin R (2009) Technical Guidance for Assessment and Mitigation of the Hydroacoustic Effects of Pile Driving on Fish. Prepared for California Department of Transportation. www.dot.ca.gov/hq/env/bio/fisheries_bioacoustics.htm.

Palazzi R, Richard J, Bozzato G, Zanella L (2006) Larval and juvenile rearing of common sole (*Solea solea* L.) in the Northern Adriatic (Italy). *Aquaculture* 255:495-506

Popper AN, Carlson TJ, Hawkins AD, Southall BL & Gentry RL (2006). Interim criteria for injury of fish exposed to monopile driving operations: a white paper. Report prepared for the California Department of Transportation. www.dot.ca.gov/hq/env/bio/files/piledrivinginterimcriteria_13may06.pdf

Popper AN, Hastings MC (2009) The effects of anthropogenic sources of sound on fishes. *Journal of Fish Biology* 75:455-489

Prins TC, van Beek JKL, Bolle LJ (2009) Modellschatting van de effecten van heien voor offshore windmolenparken op de aanvoer van vislarven naar Natura 2000. *Deltares rapport Z4832*

Riley JD, Symonds DJ, Woolner LE (1986) Determination of the distribution of the planktonic and small demersal stages of fish in the coastal waters of England, Wales and adjacent areas between 1970 and 1984. *Fish Res Tech Rep No* 84:1-23

Ryland JS (1966) Observations on the development of larvae of the plaice, *Pleuronectes platessa* L., in aquaria. *J Cons perm int Explor Mer* 30:177-195.

Stadler JH, Woodbury DP (2009) Assessing the effects to fishes from pile driving: Application of new hydroacoustic criteria. Inter-Noise 2009, August 23-26, Ottawa, Canada

Trotter AJ, Pankhurst PM, Hart PR (2001) Swim bladder malformation in hatchery-reared striped trumpeter *Latris lineata* (Latridae). Aquaculture 198:41-54

van der Land MA (1991) Distribution of flatfish eggs in the 1989 egg surveys in the south-eastern North Sea, and mortality of plaice and sole eggs. Netherlands Journal of Sea Research 27:277-286

Weston DE (1976) Propagation in water with uniform sound velocity but variable-depth lossy bottom. Journal of Sound and Vibration 47:473-483

Woodbury DP, Stadler JH (2008) A proposed method to assess physical injury to fishes from underwater sound produced during pile driving. Bioacoustics 17:289-291

Wysocki LE, Davidson JW, Smith ME, Frankel AS, Ellison WT, Mazik PM, Popper AN, Bebak J (2007) Effects of aquaculture production noise on hearing, growth, and disease resistance of rainbow trout *Oncorhynchus mykiss*. Aquaculture 272:687-697

Zijlstra JJ, Dapper, R., Witte, J.IJ. (1982) Settlement, growth and mortality of post-larval plaice (*Pleuronectes platessa* L.) in the western Wadden Sea. Neth J Sea Res 15:250-272

Justification

Rapport C029/11

Project Number: 4302501504 & 4302501507

The scientific quality of this report has been peer reviewed by the a colleague scientist and the head of the department of IMARES.

Approved: Mark Dickey-Collas
Senior scientist

Signature: 

Date: 23 June 2011

Approved: Jakob Asjes
Head of Department

Signature: 

Date: 23 June 2011

Appendix A. TNO memo 1



TNO Science and Industry

Memorandum

From

C.A.F. de Jong

Subject

The effect of piling noise on the survival of fish larvae - pilot experiments - memo-1: definition of acoustic signals and suggestions for experimental set-up

Date

2 September 2010

SUMMARY

This memo describes the first worked-out thoughts for the design of an experimental set-up to study the effect of piling noise on the survival of fish larvae. Several options for generating representative signals in a laboratory environment are evaluated. It is concluded that the most promising option is to develop an exposure chamber, driven by an underwater loudspeaker.

1 Introduction

This is the first memorandum in the preparation of pilot experiments for determining the effect of underwater noise due to pile driving on the survival of fish larvae. It addresses the definition of the acoustic signals that the larvae will be exposed to in an experimental set-up and discusses how representative of pile driving noise these signals can be made in an experimental set-up. This memo addresses several issues that were originally planned for the second memorandum, because of the strong connection between the definition of the acoustic signals and the design of the experimental set-up.

2 Background

A tentative conclusion of the study towards an appropriate assessment for the environmental impact of the offshore wind farms by Prins et al [1] was that pile driving may have a significant impact on the number of fish (plaice, sole and herring) larvae reaching Natura 2000 sites *Noordzeekustzone* and *Waddenzee*. Model calculations of the transport of eggs and larvae under influence of the impact of pile driving noise, assuming that mortality occurs up to 1000 m from a pile driving site, indicate that the number of fish reaching the Natura 2000 sites may decrease by 3 to 9%. The assumed mortality radius is not based on evidence. Actually, there is a large uncertainty about the vulnerability of fish eggs and larvae to piling noise (impulsive sound) and the spatial scale at which mortality or injury will occur [2].

To mitigate this important gap in the knowledge, a pilot study is proposed in the framework of the 'Masterplan short list' studies for the NL Ministry of Transport, Public Works and Water affairs. Further studies in this field were proposed in a ZKO project. The pilot studies are proposed to accelerate the knowledge development, to meet the time line driven by the offshore wind plans.

3 Objective

The objective of the proposed pilot study is to determine whether levels of underwater noise from piling activities can result in immediate mortality or injury to fish larvae (i.e. to lethal or sub-lethal effects). The

piling noise should be representative at distances from 100 m to 2 km from the piling installation in an offshore environment.

4 Characterizing underwater noise due to pile driving

Piling noise in connection with the impact on marine life is usually quantified in terms of Sound Exposure Level (SEL in dB re $1 \mu\text{Pa}^2\text{s}$; per strike and/or cumulative) and peak sound pressure (value in μPa or level in dB re $1 \mu\text{Pa}^2$). Other possible measures (particle velocity, impulse, rise time, peak to peak sound pressure, kurtosis, etc.) are sometimes suggested, but the associated dose-response relations are even less clear than for SEL and peak pressure. Hence, other measures are not primarily considered, because the author is not aware of any references in which these are clearly related to effects.

Peak sound pressure is here defined as the maximum absolute value of the unweighted instantaneous sound pressure in the measurement bandwidth. *Peak sound pressure level* is ten times the logarithm to the base 10 of the ratio of the square of the peak sound pressure to the square of the reference sound pressure of $1 \mu\text{Pa}$.

Sound Exposure is defined as the time integral of the time-varying square of the unweighted instantaneous sound pressure in the measurement bandwidth over the duration of a single piling impact. *Cumulative Sound Exposure* is the sound exposure summed over multiple piling impacts. *Sound Exposure Level (SEL)* is ten times the logarithm to the base 10 of the ratio of the sound exposure to the reference sound exposure of $1 \mu\text{Pa}^2\text{s}$.

In 2008, the US Caltrans Fisheries Hydro-acoustic Working Group has issued an Agreement in Principal for Interim Criteria for Injury to Fish from Pile Driving Activities [3]. The agreed criteria identify maximum received peak sound pressure levels of 206 dB re $1 \mu\text{Pa}^2$ and 187 dB re $1 \mu\text{Pa}^2\text{s}$ accumulated SEL for all listed fish except those that weigh less than 2 g, for which the threshold for the accumulated SEL is 183 dB re $1 \mu\text{Pa}^2\text{s}$. No frequency weighting is mentioned in relation with dose-response relationships for fish.

5 Available information of underwater noise due to pile driving

TNO has measured the underwater noise during the piling for the Q7 offshore wind farm [4,5]. At a distance of 1 km from the hammering of a 4 m diameter pile in about 20 m water depth with a sand bottom, the broadband SEL per stroke was about 172 dB re $1 \mu\text{Pa}^2\text{s}$ and the zero-to-peak pressure level ('peak level') about 195 dB re $1 \mu\text{Pa}^2$. The dominant noise occurred at frequencies between circa 50 Hz and 1 kHz. In UK measurements [6] at a distance of 57 m from a 2 m diameter pile the observed SEL was 178 dB re $1 \mu\text{Pa}^2\text{s}$ and the peak level 208 dB re $1 \mu\text{Pa}^2$. Both measurements were carried out for piling with the same hydraulic hammer at approximately the same stroke energy. The sediment into which the pile was driven was different (Q7: sand; UK: chalk), as was the water depth (Q7: 20-23 m, UK: 10-15 m). Scaling of sound levels with pile diameter, stroke energy, water depth, sediment properties, etc. is currently unknown. This will be investigated under another Masterplan WIND short list study. However, a comparison was made between various measurements of pile driving noise in [7]. Table 4.2 (from the Errata with [7]) provides an overview of the measurement data, with a scaling to a distance of 500 m from the piling location. At a distance of 500 m, scaled values of SEL vary between 155 and 178 dB re $1 \mu\text{Pa}^2\text{s}$ and peak levels vary between 180 and 200 dB re $1 \mu\text{Pa}^2$. Using the same scaling to estimate the levels at 100 m distance would lead to values that are about 10 dB ($=15\log_{10}(500/100)$) higher, i.e. SELs between 165 and 188 dB re $1 \mu\text{Pa}^2\text{s}$ and peak levels between 190 and 210 dB re $1 \mu\text{Pa}^2$.

In a large survey of underwater noise due to pile driving in shallow water [3] levels were scaled to 10 m from the pile. Impact driving on steel piles (of diameter larger than 1 m) in these studies (Table I.2-1) led to SEL values between 180 and 195 dB re $1 \mu\text{Pa}^2\text{s}$ and peak levels between 208 and 220 dB re $1 \mu\text{Pa}^2$. Scaling these to 100 m distance, assuming a worst case scenario with a cylindrical spreading loss ($10\log R$ -

scaling) leads to estimated SELs between 170 and 185 dB re $1 \mu\text{Pa}^2\text{s}$ and peak levels between 198 and 210 dB re $1 \mu\text{Pa}^2$. These are close to the estimations based on the North Sea piling noise measurements.

For piling noise impulses, the difference between the numerical values of the peak pressure level and SEL is in the order of 20 to 25 dB, where the higher differences (shorter pulses) occur at positions closer to the pile. Each simulated pile driving signal should exhibit a similar level difference to be representative. The difference of peak pressure level and SEL has the dimension of dB re 1 s^{-1} . It is related to signal duration. The larger this difference, the shorter the signal, hence it is a measure of the ‘impulsiveness’ of the signals.

Particle velocity

Measurement data of particle velocity due to pile driving is very scarce. Some data can be found in [8]. This concerns impact driving of 76 cm diameter, 2.4 m long steel piles in a water depth of 10 m. At 10 m distance (and 5 m depth) the average peak pressure level was found to be 204 dB re $1 \mu\text{Pa}^2$ and the SEL¹ 178 dB re $1 \mu\text{Pa}^2\text{s}$. The measured peak velocity level was 141 dB re $1 (\text{nm/s})^2$ and the 90% RMS velocity level was 129 dB re $1 (\text{nm/s})^2$. At larger distances, the acoustic particle velocity and acoustic pressure levels are approximately related through the characteristic impedance of the medium, i.e. the velocity level in dB re $1 (\text{nm/s})^2$ equals the pressure level in dB re $1 \mu\text{Pa}^2$ minus $20 \log_{10} \left\{ \rho c \cdot \left(10^6 / 10^9 \right) \right\} \approx 64 \text{ dB}$. This includes a correction for the factor that accounts for the different reference units. Hence the measured peak pressure would correspond with a free field peak velocity of 141 dB re $1 (\text{nm/s})^2$ and the rms pressure corresponds with rms velocity level 129 dB. These are close to the measured values, which means that use of the free-field relationship does not result in large errors in this case.

6 Requirements for simulated piling noise levels.

Based on the overview in the previous section, signals representative of pile driving noise at distances from 100 m to 2 km from the piling installation, have broadband peak pressure levels up to about 210 dB re $1 \mu\text{Pa}^2$ (i.e. 32 kPa) and broadband single impulse SEL up to 188 dB re $1 \mu\text{Pa}^2\text{s}$. Assuming that the broadband propagation loss varies with circa $15 \log(\text{distance})$, the corresponding levels at 2 km distance are about 20 dB lower (i.e. SEL 168 dB re $1 \mu\text{Pa}^2\text{s}$ and peak level 190 dB re $1 \mu\text{Pa}^2$). The corresponding broadband peak particle velocity levels should be between 127 and 147 dB re $1 (\text{nm/s})^2$ and the broadband integrated velocity exposure levels between 104 and 124 dB re $1 (\text{nm/s})^2\text{s}$.

7 Requirements for simulated piling noise spectra.

Some typical piling underwater noise SEL spectra are given in Figure 1, see the properties in Table 1. The spectra of the noise measured at the Q7 site are similar. This shows that the main (unweighted) energy is generated in the 50 Hz to 1 kHz bands.

¹ This SEL is derived from the 90% RMS SPL plus $10 \log_{10}(T_{90} \text{ signal duration})$, both provided in the report. The SEL value given in the report seems to be 6 dB too high.

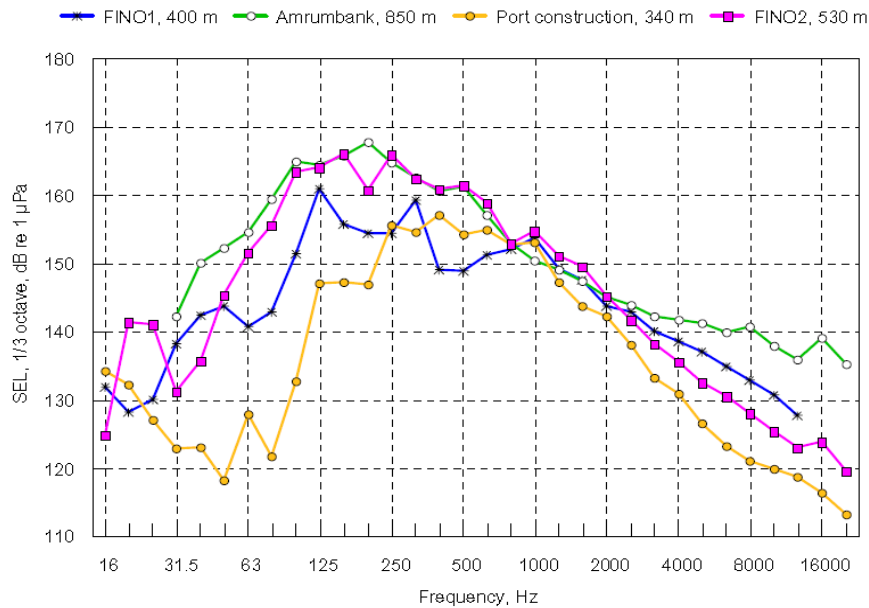

Figure 1. Third-octave band spectra of the single stroke SEL of some of the pile-driving operations, from Nehls *et al.* (2007), see also Table 1.

Table 1. Summary of measurement results for different pile driving operations, from [7]. The ‘normalized’ levels are scaled to a distance of 500 m in 20 m water depth.

Project	Pile diameter [m]	Water depth [m]	Measuring depth [m]	Measuring Distance [m]	Blow energy [kJ]	Peak Level [dB re 1 μPa^2]	SEL [dB re 1 $\mu\text{Pa}^2\text{s}$]	Normalized Peak Level [dB re 1 μPa^2]	Normalized SEL [dB re 1 $\mu\text{Pa}^2\text{s}$]
Jade port construction, Germany, 2005	1.0	11	5	340	70-200	190	164	186	160
FINO 1, Germany, 2001	1.6	30	10	750	80-200	192	162	196	166
FINO 2, Germany, 2006	3.3	24	5	530	300	190	170	191	171
Amrumbank West, Germany, 2005	3.5	23	10	850	550	196	174	200	178
Test Pile, UK, 2006	2.0	8-15	?	57	800	208	178	193	163
Test Pile, UK, 2006	2.0	8-15	4-7	1850	800	188	164	195	171
Q7 site, NL, 2006	4.0	20-25	8-15	890-1200	800	195	172	200	177

A closer investigation of wave form and spectral content for a typical piling stroke signal confirms that it is sufficient to reproduce the piling noise is the frequency range between 50 Hz and 1 kHz. This analysis is done for piling stroke signals, recorded at the North Sea site (depth about 20 m) at a distance of 100 m from the pile. Figure 2 shows the recorded wave form and the resulting wave form after applying a cosine-tapered (Tukey) band-pass filter (1050 points, with 50 Hz taper to zero).

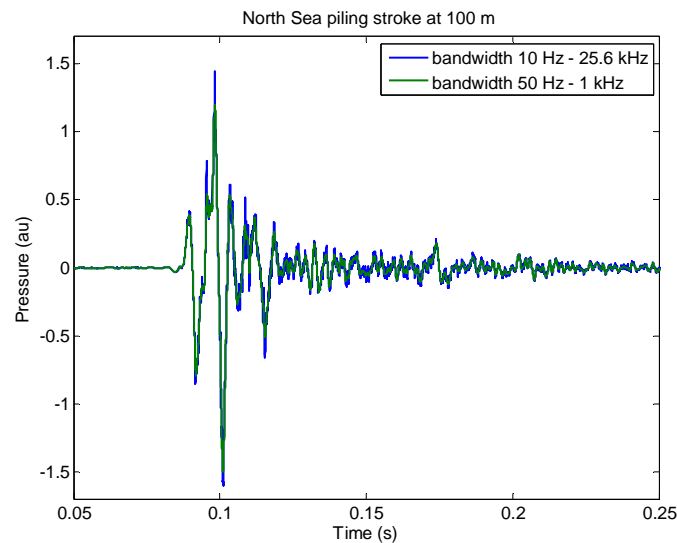

Figure 2. Underwater noise signal for a single piling noise stroke, recorded at the North Sea site at a distance of 100 m from the pile, for two different bandwidths. The amplitude scale is not calibrated ('au'='arbitrary unit').

It can be seen that the waveform is not significantly affected by the filtering. The resulting SEL and peak levels for the two different bandwidths differ less than 1 dB. Note that the peak level is determined by the negative peak just after 0.1 s.

Hence the simulated piling noise signals in the proposed study should fulfil the following criteria to be representative:

6. Broadband peak sound pressure level between 190 and 210 dB re $1 \mu\text{Pa}^2$
7. Broadband SEL value per pulse at least 22 dB below the Peak Level value (i.e. SEL between 168 and 188 dB re $1 \mu\text{Pa}^2\text{s}$)
8. Broadband peak particle velocity level between 127 and 147 dB re $1 (\text{nm/s})^2$
9. Broadband integrated velocity exposure levels between 104 and 124 dB re $1 (\text{nm/s})^2\text{s}$.
10. Main energy between 50 Hz and 1 kHz.

The difference between the peak level and SEL accounts for the impulsiveness of the signals. Note that the lower frequency of 50 Hz is probably connected with the cut-off frequency for shallow water sound propagation. For piling in deeper water the lowest frequency of interest may be lower.

8 Definition of acoustic signals

The criteria that are described in the previous section can be fulfilled by various acoustic signals. Since the actual underwater sound due to pile driving will vary for different piling activities in different environments and also between different piling strokes and at different measurement locations relative to the pile, it is considered sufficient, for the proposed exposure tests, to select specific representative acoustics signals, which fulfil the above criteria. These signals can be actual recordings of piling noise or synthesized or mechanically generated impulsive signals. Actual recordings have the benefit that the signals also represent signal characteristics that are not covered by the proposed criteria. The options for generating signals are considered in the following sections, in connection with proposals for the experimental set-up.

Each trial of the proposed exposure study will consist of 4 sound exposures and 1 control group. These 5 treatments will be repeated during a 2nd and 3rd trial. The first trial will be used to crudely examine the sensitivity range of larvae to various acoustic parameters. The results of the first trial will be used to focus on relevant parameters during the second trial. Each batch of 50 larvae will be exposed only once, so a trial consists of a single acoustic exposure.

Signals representative of pile driving noise at distances of 100 m and 2 km from the piling installation differ about 20 dB in level. It is proposed to carry out the first trial at the highest level and to select the levels for the following trials on the basis of the initially observed effects on the larvae. If mortality is observed, the next trial could be carried out at e.g. a 10 dB lower level. The selection of the four test signals is still open for discussion with IMARES.

9 Options for pilot experiments in a laboratory setting

Due to budget and time limitations, which prohibits full scale experiments during actual offshore piling activities, it was decided to execute pilot exposure experiments in which fish larvae are exposed to underwater acoustic signals that are representative for piling noise, in a laboratory setting. Three options are considered:

1. experiments in a water tank or basin
2. experiments in a pipe wave guide
3. experiments in a compact chamber

Option 1 is based on the experience obtained at SEAMARCO with behavioural response studies with harbour porpoises, harbour seals and fish in the SEMARCO facilities in Wilhelminadorp.

Option 2 is based on publications from Mardy Hastings and colleagues [9], who developed a pipe test arrangement to expose fish to sound.

Option 3 is based on publications by Lewis et al [10], who developed a so-called ‘fishabrator’ sound exposure chamber for assessing the effects of high-intensity sound on fish.

Unfortunately, we have found just one publication [9] in which the test pipe was used to study exposure effects and no publications of studies carried out with the ‘fishabrator’. The authors have not (yet?) responded on questions posed via email.

10 Option 1: Experiments in a water tank or basin

In a tank, the sound field is influenced by reflections at the walls and at the water surface [11]. At the lowest frequencies (determined by the smallest dimension of the tank and the acoustic wavelength in water), sound propagation away from the source is strongly attenuated. At intermediate frequencies the sound field is characterized by resonances in the tank and at higher frequencies, the resonance frequencies are so closely spaced that the reverberant sound field in the tank becomes homogeneous, with the direct field of the source, subject to spherical spreading, superimposed on it. To avoid excessive ‘colouring’ of the sound by resonant modes, the minimum size of the tank should be larger than the acoustic wavelength at the lowest frequency of interest. For piling noise at frequencies larger than 50 Hz, the minimum size should be larger than 30 m. In shallower tanks, the low frequency components of the piling noise decrease exponentially with distance.

For experiments in a tank, the Lubell LL1424HP projector (recently acquired by SEAMARCO) is the most powerful loudspeaker that could be made readily available. It operates in the range between 200 Hz and 9 kHz, with a maximum rms output of 197 dB re 1 $\mu\text{Pa}^2\text{m}^2$ at a single narrowband frequency near 600 Hz (172 dB @ 200 Hz, 190 dB @ 1 kHz). This does not give direct information about the achievable peak and

SEL levels. However, with the smaller Lubell 916 (max output 180 dB re $1 \mu\text{Pa}^2\text{m}^2$ at 1 kHz) we have been able to produce impulsive signals with peak level 177 dB re $1 \mu\text{Pa}^2$ and SEL 145 dB re $1 \mu\text{Pa}^2\text{s}$ at a distance of 1 m from the projector. This suggests that the maximum achievable levels for the LL1424HP are about 17 dB higher: 194 dB re $1 \mu\text{Pa}^2$ and SEL 162 dB re $1 \mu\text{Pa}^2\text{s}$. These are about 16 dB too low compared with the requirements for the fish larvae experiments.

It can be concluded that experiments in a tank are not appropriate for studies of mortality of fish larvae due to piling noise.

11 Option 2: Experiments in a water filled pipe

In a pipe, the sound field is one-dimensional and plane sound waves propagate along the pipe axis without losses due to spatial spreading. To avoid propagating higher-order acoustic modes in the pipe, the diameter of the pipe should be smaller than 0.586 times the acoustic wavelength in water [12]. For frequencies up to 1 kHz, this condition is met for diameters smaller than 0.88 m.

Samples of 50 larvae are to be kept in a compact volume of about 1 litre of water. Assuming that this volume should be contained by a cylindrical tube over a length approximately equal to the diameter, the internal diameter should be at least 0.11 m. Of course, the test section in which the larvae are kept could be bigger than the pipe diameter, but this will introduce additional reflections that are better avoided.

The pipe could be made of e.g. (transparent) PolyMethyl MethAcrylate (PMMA; also known as 'Plexiglas' or 'Perspex'). Such a test arrangement has been used by Hastings [9] to expose fish to sound, see FIG.1 below. In their setup the Plexiglas pipe had an inner diameter of 0.12 m and a length of 15 m.

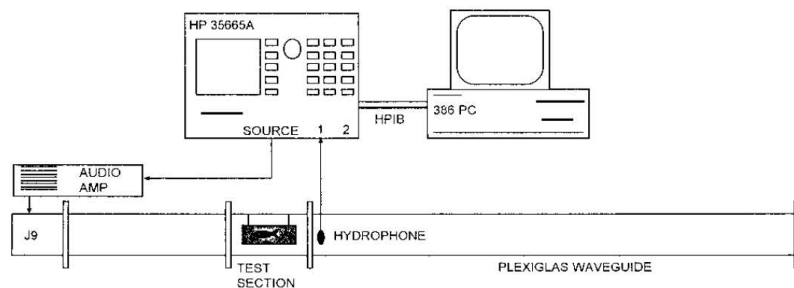

FIG. 1. Schematic diagram of the experimental setup showing the 15-m-long Plexiglas® waveguide, the removable section of the waveguide in which the fish was located, and the position of the J-9 projector that was used as the sound source.

Advantages of using PMMA are the possibility to observe the larvae, relatively easy machining and available components and shorter wavelengths and higher damping than e.g. steel, which reduces the effects of resonances in the pipe, as explained in the following paragraphs.

In a pipe, the sound field may be influenced by reflections at the pipe ends. These can lead to standing waves in which sound pressure and particle velocity are strongly position dependent. Effects of reflections at the far end may be reduced by reducing the reflection coefficient (e.g. by shaping the pipe end into a horn, or by applying sound absorbing constructions/materials at the pipe end) and by increasing the pipe length, so that the reflected waves are attenuated by the losses in the pipe wall.

The attenuation depends on the wavelength and the loss factor for the plane waves in the pipe. The wave speed for plane waves in a flexible pipe is lower than the sound speed in unbounded water [12]. Taking for the PMMA a modulus of elasticity of 3200 MPa and a mass density of 1200 kg/m³, the plane wave speed (modified by the flexibility of the wall) in a pipe of 120 mm internal diameter and 5 mm wall thickness is about 355 m/s. In the setup of Hastings [9], reflections were significant at 60 Hz in a 15 m long Plexiglas pipe. The measurement results show that the plane wave attenuation was about 2 dB/m at 300 Hz (i.e. absorption coefficient ~0.043).

For the current experiments, the setup should consist of a pipe of at least 15 m length. (Note: A greater pipe length, or horn-shaped end, connected to a water tank would be beneficial.) This would create a well defined acoustic environment in which the particle velocity (in the frequency range between 50 Hz and 1 kHz) can be estimated from sound pressure measurements (e.g. using 3 hydrophones, B&K8103, or pressure transducers, available at TNO).

Note, that the ratio between sound pressure and particle velocity in this Plexiglas pipe differs from that in plane waves the sea. At the same sound pressure, the plane wave particle velocity in the pipe will be about 5 times greater than in unbounded water, because the wave speed is about 5 times lower.

The particle velocity at the location of the larvae can be determined by means of the ‘two microphone method’ [12]. This uses the signals of two pressure measurements at an axial distance d . It can be used in range $0.08\pi \leq kd \leq 0.8\pi$, which spans a decade of frequencies for a fixed distance d . For the range of 100 Hz to 1 kHz, with a wave speed of 355 m/s, the distance d should be 14 cm, or 28 cm for the range from 50 Hz to 500 Hz. Hence the frequency range between 50 Hz and 5 kHz can be covered by three pressure sensors at 14 cm distance.

Note that the above analysis is based on preliminary estimations of the material properties of the PMMA. It is recommended to obtain a more accurate estimation of these properties before the final design of the setup (pipe lengths, transducer positions, etc.)

Excitation by an underwater sound projector

In the pipe experiment, Hastings [9] used a USRD J9 sound projector. The maximum produced SPL was about 180 dB re 1 μPa^2 at 300 Hz, which is too low for our purpose. It is not clear whether they could have generated higher pressures in their setup.

TNO has a somewhat bigger USRD J11 sound projector available, which could be used in such a setup. It operates in the frequency range between 20 Hz and 12 kHz. The maximum free field source level (SL) of this source (between 50 Hz and 1 kHz) is about 150 dB re 1 $\mu\text{Pa}^2\text{m}^2$. To estimate the maximum output when driving the fluid in a pipe, we assume that the radiation impedance that is experienced by the piston of the J11 remains approximately the same in both cases. That means that the volume velocity produced by the J11 remains the same. The volume velocity Q can be estimated from the free field source level:

$Q = 4\pi 10^{(SL-120)/20} / \rho c \approx 265000 \mu\text{m}^3/\text{s}$. If the piston drives a long PMMA pipe with a diameter of 15 cm with this volume velocity, the corresponding plane wave rms pressure is about 22.5 kPa, i.e. 207 dB re 1 μPa^2 . Since the peak levels are at least 3 dB higher, this suggests that it should be in principle possible to use the J11 to generate the required levels in the pipe, in the required frequency range.

The advantage of using a sound projector is that one has control over the signals. One could synthesize arbitrary signals or send out actually recorded sounds of piling strokes.

Excitation by an impact hammer

Alternatively, one could consider the use of an impact hammer to drive the fluid in the pipe. If the pipe would be driven via a rigid piston at one end, of 160 mm diameter, this would require a peak force of 643 N to generate a peak pressure level of 210 dB re 1 μPa^2 (i.e. 32 kPa). In a plane wave, the SEL corresponds with an acoustic energy $E = (A/\rho c) \cdot 10^{(SEL-120)/10}$, where A is the cross-sectional area of the fluid in the pipe and ρc is the characteristic impedance of the water in the pipe. Hence, a SEL of 190 dB re 1 $\mu\text{Pa}^2\text{s}$ in a PMMA pipe of 15 cm diameter filled with water equals about 0.55 J. The 20 dB lower level (for the pulse at 2 km from the pile) equals about 5.5 mJ.

Consider a rigid mass m with a velocity v_0 that impacts at time $t=0$ on the end plate of a semi-infinite fluid-filled pipe infinitely long elastic rod. The input mobility for the pipe wall, with area A_s , Young's modulus E_s and density ρ_s equals $Y_s = 1/A_s \sqrt{E_s \rho_s}$, the mobility of the fluid column within the pipe equals $Y_f = 1/A \rho c$. If the pipe is driven via a rigid end plate, the combined mobility equals $Y = 1/(1/Y_s + 1/Y_f)$.

The driving force during impact depends on the details of the contact. The velocity of the end plate on impact follows from conservation of momentum. The required mass and impact velocity can be estimated for a fully elastic collision, estimating the momentum (I) of the pipe from the mass associated with a half wavelength in fluid and wall associated with the impact duration. The energy transmitted during the impact time t_i equals about $E \approx I^2 Y / \pi t_i$. The impact time depends on the contact area and contact stiffness. This can be influenced by the choice of 'hammer' shape and material.

This leads to the initial estimation that the required energy and peak pressure can be generated by dropping a mass² of 1 kg from a height of 0.5 m, provided that the impact time can be limited to 1 ms. This seems feasible.

Using a hammer leads to a single short impulse that travels down the pipe. Although this impulse signal can fulfil the criteria that are described in §51, it deviates from actual offshore pile driving noise, which contains several compression and rarefaction peaks due to reflections in the pile and at water surface and bottom. In a 15 m long PMMA pipe (wave speed 355 m/s), the first reflections arrive after about 94 ms. More realistic times between reflections (in the order of ms) could be achieved in a much shorter pipe. But it will be very difficult to design that pipe and the pipe end in such a way that the reflections are representative for actual piling noise signals.

12 Option 3: Experiments in a compact chamber

A water volume that is small compared with the acoustic wavelength does not support acoustic waves, but behaves uniformly as a mass or stiffness, dependent on the boundary conditions. These uniform conditions are exploited in the 'fishabrator', see Figure 3.

² See the spreadsheet fishpipe.xls for details.

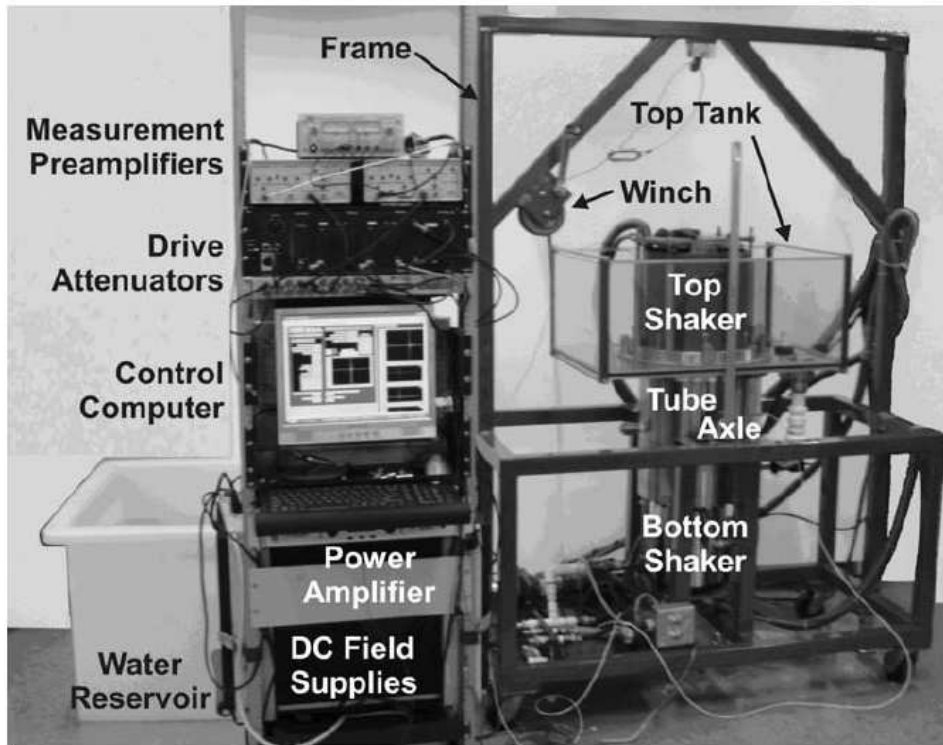

Figure 3. The ‘fishabrator’ at the George W. Woodruff School of Mechanical Engineering, Georgia Institute of Technology.

At a maximum frequency of 1 kHz, the acoustic wavelength in water is about 1.5 m, which means that a chamber with a maximum dimension smaller than 25 cm is smaller than $1/6^{\text{th}}$ of a wavelength and hence behaves uniformly.

In such a chamber, effects of pressure and particle velocity can be tested independently: By driving a rigidly enclosed chamber, the pressure is raised with negligible particle velocity, while by driving a semi-open chamber, the velocity is raised at negligible increase of pressure. In the ‘fishabrator’, the control of the ratio between sound pressure and velocity is further enhanced by supplying two controlled exciters. For the purpose of the proposed study with fish larvae this is not necessary, which simplifies the design of the setup.

Figure 4 shows the geometry of the J11 projector³. It is proposed to design a cylindrical chamber that fits tight to the ring that surrounds the driving piston. The inner diameter of that chamber is then about 15 cm. With the height of the water column 10 cm, the water volume is about 1.8 litres, which should be large enough for the batches of larvae that we want to study.

³ As an alternative, TNO also can use the Actran LFPX projector, which can produce 10-12 dB higher levels than the J11, in the same frequency range.

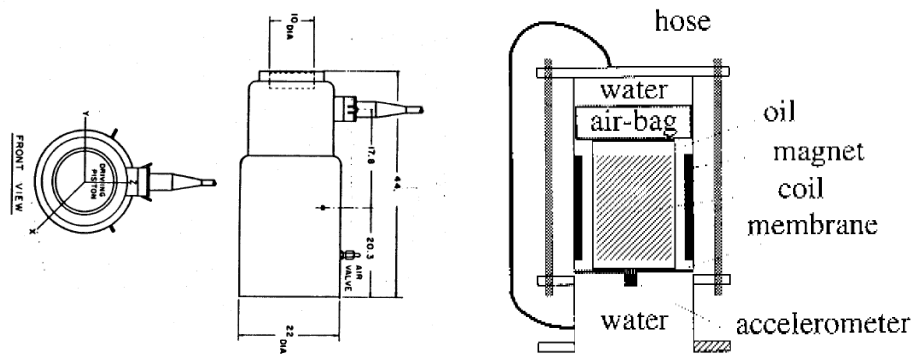

Figure 4. Sketch of the USRD J11 projector (left, dimensions in cm) and of a similar set-up (right) in which the J11 source was used to excite fluid pulsations in a pipe (from [12]).

Two configurations can be used:

1. **Pressure excitation**, with the chamber closed by a ‘rigid’ lid on top. Note that it is very important to avoid enclosing air bubbles in the chamber, because these have a large impact on the compressibility of the fluid. Only the larvae are allowed to influence that compressibility.
2. **Velocity excitation**, with the chamber open on top (or closed by a very flexible membrane, to keep the fluid and the larvae inside).

In configuration 1, chamber and lid should be tight and rigidly connected to the projector housing. The axial and circumferential stiffness of the chamber should be larger than the effective stiffness of the fluid volume. This can be achieved by a steel chamber with walls of (at least) 5 mm thickness.

The acoustic pressure can be measured by pressure transducers, mounted flush in the wall, half way the chamber. The particle velocity can be measured by a (watertight) accelerometer mounted on the surface of the piston of the projector.

Figure 5 shows the predicted response in the chamber for the two excitation types. For frequencies up to ca. 1.5 kHz, the calculated velocity response exhibits mass-behaviour ($v/p \propto 1/f$) with the lid open and stiffness-behaviour ($v/p \propto f$) with the lid closed. The set-up shows a $1/4$ -wavelength fluid resonance near 3500 Hz. Note that these calculations assume a rigid connection between the chamber and the projector casing. This requires special attention, because any reduced stiffness in this connection may cause the resonance to shift down into the frequency range of interest (50 Hz-1 kHz).

With an open end, the acoustic velocity decreases with frequency, due to the inertia of the water mass. In order to obtain a realistic velocity pulse, the driving signal has to be equalized to correct for this effect. The required velocity level is -64 dB re $1 \text{ (nm/s/}\mu\text{Pa)}^2$. The corresponding pressures are much lower than those for the closed chamber.

The predicted pressure response of the closed chamber is flat for frequencies up to ca. 1.5 kHz.

Note that the actual response of the projector and chamber will have to be determined experimentally. Additional resonances in the response may possibly be compensated by an appropriate matched filtering of the driving signal.

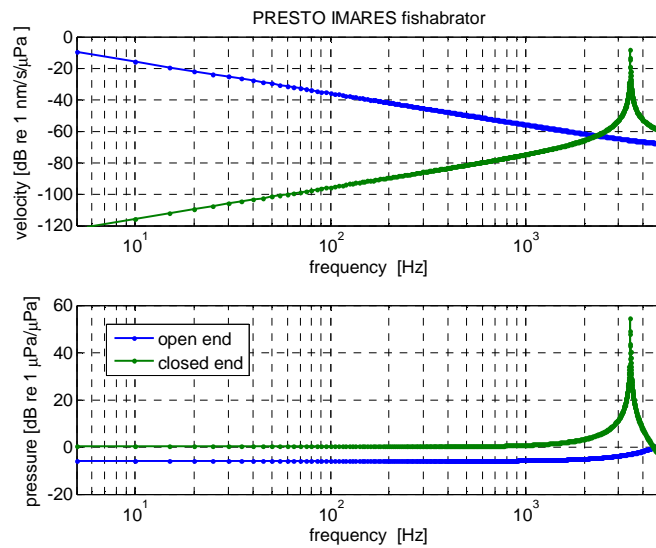

Figure 5. *PRESTO* [12] simulation for the proposed exposure chamber (inner diameter 15 cm, wall thickness 1 cm, inner height 10 cm, lid thickness 1 cm, steel cylinder). The pulsations are generated by a 10 cm diameter piston at the lower end. The chamber wall is clamped at the lower end. Two configurations: with lid ('closed end', i.e. 'pressure excitation') and without lid ('open end', i.e. 'velocity excitation'). The calculated particle velocity (top) and pressure (bottom) at the mid plane of the chamber per unit pressure at the piston.

13 Options 2 and 3 compared

In summary, both the pipe (option 2) and the chamber (option 3) can be used for the proposed exposure tests. Both can make use of an existing underwater loudspeaker to generate the required acoustic signals, by playing back actual recorded or synthesized sounds.

The chamber has the advantage of a compact and relatively simple set-up, which needs less space for mounting than the tube. Moreover, the sound exposure in the chamber is well defined: either uniform acoustic pressure or uniform acoustic velocity, that can be measured directly. It cannot represent the actual combination of pressure and velocity excitation that is experienced at sea during piling, but it can be argued that the physical effects that may lead to damage are more or less independent for larvae (which are much smaller than the acoustic wavelengths to which they are exposed): pressure fluctuations may lead to damage due to compression and decompression, while damage due to velocity fluctuations is mainly related with inertial effects (e.g. of the otolith organs).

The tube has the advantage that it provides a plane wave exposure, provided that the tube design avoids significant reflections at the end of the tube. However, the characteristic impedance in a PMMA tube differs by a factor of five from that in free water. In the tube, the particle velocity is measured indirectly: derived from measurements of the gradient of the acoustic pressure. Another disadvantage of the tube is that it is more difficult to design a facility for placing the larvae in the tube, without influencing the acoustic field with entrained air bubbles.

14 Conclusion

It seems possible to execute the pilot experiments in a laboratory setting. Three different options are worked out. The last option (the 'larvaebrator' exposure chamber) seems the most attractive. It provides a compact and simple setup with a possibility to test the response of the larvae to pressure and velocity signals independently. This independent testing requires a doubling of the amount of trials at a given level of exposure. This should be taken into account in the development of the test plans.

15 References

1. T.C. Prins, *et al.* 2008 <http://www.noordzeeloket.nl/overig/bibliotheek.asp>: Deltares. report Z4513 'Development of a framework for appropriate assessment of Dutch offshore wind farms'
2. A.N. Popper & M.C. Hastings 2009 *Journal of Fish Biology* **75**, 455-489. 'The effects of anthropogenic sources of sound on fishes'
3. R. Oestman, D. Buehler, J.A. Reyff and R. Rodkin 2009 Sacramento: California Department of Transportation. 'CALTRANS Technical Guidance for Assessment and Mitigation of the Hydroacoustic Effects of Pile Driving on Fish'
4. C.A.F. de Jong & M.A. Ainslie 2008 Delft: TNO Science and Industry. report MON-RPT-033-DTS-2007-03388 'Analysis of the underwater sound during piling activities for the Off-shore Wind Park Q7'
5. C.A.F. de Jong & M.A. Ainslie 2008 *Proc. ECUA 2008 (Acoustics'08)*. Paris, 1-6. 'Underwater radiated noise due to the piling for the Q7 Offshore Wind Park'
6. S.P. Robinson, P.A. Lepper and J. Ablitt 2007 *Proc. Oceans 2007 - Europe*. Aberdeen 'The measurement of the underwater radiated noise from marine piling including characterisation of a "soft start" period'
7. M.A. Ainslie, *et al.* 2009 The Hague: TNO. report TNO-D 2009 C085 'Assessment of natural and anthropogenic sound sources and acoustic propagation in the North Sea'
8. A. MacGillivray & R. Racca 2005 Victoria, BC, Canada: JASCO Research Ltd. report for Washington State Department of Transportation 'Sound pressure and particle velocity measurements from marine pile driving at Eagle Harbor maintenance facility, Bainbridge Island WA'
9. M.C. Hastings, A.N. Popper, J.J. Finneran and P.J. Lanford 1996 *Journal of the Acoustical Society of America* **99**(3), 1759-1766. 'Effects of low-frequency underwater sound on hair cells of the inner ear and lateral line of the teleost fish *Astronotus ocellatus*'
10. T.N. Lewis, *et al.* 1998 *Journal of the Acoustical Society of America* **103**(5), 2756 'Test chamber for determining damage thresholds for high-amplitude underwater sound exposure in animal models (A)'
11. T. Akamatsu, T. Okumura, N. Novarini and H.Y. Yan 2002 *Journal of the Acoustical Society of America* **112**(6), 3073-3082. 'Empirical refinements applicable to the recording of fish sounds in small tanks'
12. C.A.F. de Jong 1994 (PhD Thesis) Delft: TNO Institute of Applied Physics. 'Analysis of pulsations and vibrations in fluid-filled pipe systems'

Appendix B. TNO memo 2



TNO Science and Industry

Memorandum

From

P.J.G. van Beek

Subject

The effect of piling noise on the survival of fish larvae - pilot experiments - memo-2: design of experimental test setup

Date

2 September 2010

1 Introduction

This is the second memorandum in the preparation of pilot experiments for determining the effect of underwater noise due to pile driving on the survival of fish larvae. It describes the practical design of the experimental test setup for testing the response of fish larvae to artificial piling noise. The concept of the setup is based on the first memo of this project [1], in which also already the final objective and background of the total project are described.

In [1] 3 options for a laboratory experiment setup were considered. It was concluded that option 3, the so-called 'larvaebrator', would be most promising: it is the most practical setup and it has the possibility to expose the larvae to pressure and velocity signals independently. During a progress meeting with IMARES on August the 3rd 2010 the recommendation for the concept of the 'larvaebrator' as experimental setup was adopted and approved by the project team [2].

The complete design phase of the experimental setup has been divided into the following items:

- Concept description,
- definition of requirement,
- technical/detailed design,
- fabrication/assembly,
- performance validation.

The latter 2 items will be covered in memo 3 of the project 'testing of the tube'.

2 Concept description

The general 'larvaebrator' design concept consists of a projector (underwater sound source) on which a compact chamber is placed. The chamber is filled with sea water and the larvae. The piston of the projector is also the bottom of the chamber and can directly excite the water with a given signal. Depending on the required boundary conditions, i.e. constant pressure or constant velocity, the top cover of the chamber can be closed (constant pressure) or released (constant velocity). Additionally, tests can be carried out with an increased pressure in the chamber, to simulate the effect of different depths in the water. The constant velocity excitation will in that case be achieved with the cover closed, but with a small layer of pressurized air between the water surface and the cover.

3 Requirements

The experimental set-up must fulfil a variety of requirements; from strict constraints to environmental conditions. Moreover there are 2 types of tests, i.e. with a pressure and with a velocity source signal, for which the setup requirements can differ.

Base requirement

The base requirement of the 'larvaebrator' is that it should be able to expose the larvae to a simulated piling noise signal, as representative as possible. Requirements regarding the pressure and velocity of the simulated noise signal itself are already given in [1]. Piling noise is a high pressure and/or high velocity transient pulse, which has consequences for the noise source i.e. projector, the housing i.e. larvae chamber and the sensors.

Projector

The projector should have enough power to reproduce the relevant characteristics of piling stroke noise as could be measured at distances between 100 and 2000 m from a pile in 20-25 m water depth at the North Sea, as explained [1]:

- It should be able to produce a broadband (50 – 1000 Hz) peak sound pressure level (SPL) between 190 – 210 dB re 1 μPa^2 .
- The projector should also be able to produce a broadband (50 – 1000 Hz) peak particle velocity level between 127 – 147 dB re 1 $(\text{nm/s})^2$.

In [1] it is demonstrated that 'broadband' in this case means that for a frequency range between 50 – 1000 Hz the waveform is hardly affected by the discarding lower and higher frequencies regarding both SEL and peak level. Therefore the requirements for the setup are limited to this frequency range.

Sensors

- Both pressure and velocity (or acceleration as measured in practice) have to be recorded during the measurements.
- The maximum acoustic peak pressure is about 3×10^4 Pa.
- The maximum peak acceleration is about 140 m/s^2 at 1 kHz.
- For both velocity and pressure the required dynamic range is about 70 – 80 dB.
- The velocity sensor(s) and cable(s) have to be fully submersible for a longer period.
- The mass of the velocity sensor should be small compared to the mass of the projector piston.

Housing

- To avoid air bubbles sticking at the wall, the internal surface of the housing should be as smooth as possible as can be achieved with conventional mechanical (milling, turning, etc.) tooling: between 0.1 and 1 μm .
- The housing also has to contain an air bleeding system to release all the remaining air (bubbles).
- To check whether all the air is released and to observe the larvae during the experiments with the pressure excitation, the top cover has to be made from transparent material.
- The housing will be filled with salt sea water and therefore has to be made from rust-resistant (stainless) material(s). Stainless steel is allowed, whereas copper/brass, etc. are not allowed.
- The 1st mechanical resonance frequency of each part of the housing has to be higher than the maximum frequency of interest, i.e. 1000 Hz.
- The volume of the housing should be between 1.5 and 2 L, with an extra requirement that the largest dimension of the volume should be less than $1/6^{\text{th}}$ of the smallest acoustic wavelength in water, which is about 250 mm at 1000 Hz.
- The mechanical stiffness of the complete setup has to be at least 10 times higher than the equivalent 'stiffness' of the water volume/column inside.

- After each exposure the batch of larvae in the chamber has to be replaced. Therefore the top cover should be easy and quick to open and close.
- It should be possible to mount pressure sensors in the housing wall.
- The housing should contain a water and pressure tight cable transit for the velocity sensor i.e. accelerometer.
- It should be possible to pressurize the fluid in the chamber with static pressures up to a maximum of 3 bar (representative of water depths up to 30 m).

Other

- To avoid any influence on the experiments from the environment, the complete setup has to be acoustically decoupled from its surroundings, which means that the set-up will be installed on rubber mounts or on a rubber plate.
- For both the pressure and velocity experiment the larvae have to be exposed to a prescribed, simulated piling signal.
The transfer function of the setup (projector, housing and water volume) will influence the signal. Therefore the source driving signal has to be corrected and filtered for this transfer function and other external disturbances, in order to retain the right piling signal in the water volume (covered in memo 3).
- The performance of the total assembled test setup has to be verified at TNO (covered in memo 3).

4 Technical design

Just like the requirements, the detailed, technical design will be split up in projector, sensor and housing part.

Projector

In [1] the USRD J11 projector is described as a possible noise source for the experiments. However, looking at the required peak pressure and velocity, it is doubted whether this projector will be able to fulfil these requirements. Therefore, another projector with more power is chosen: the USRD LFXP-4, which is also available at TNO. This projector can supply up to about 10 dB more acoustic power and should be able to fulfil the requirements. The global dimensions (in mm) of the projector are given in figure 1 and a photo is shown in figure 2. This projector can be driven by a Crown PSA-2 power amplifier, which is also available at TNO. This power amplifier can be fed with standard 230V mains voltage.

At TNO the LFXP-4 projector normally is operated in an underwater noise source set consisting of 4 equal projectors. Therefore no suitable connection cable is available and a new one has to be made.

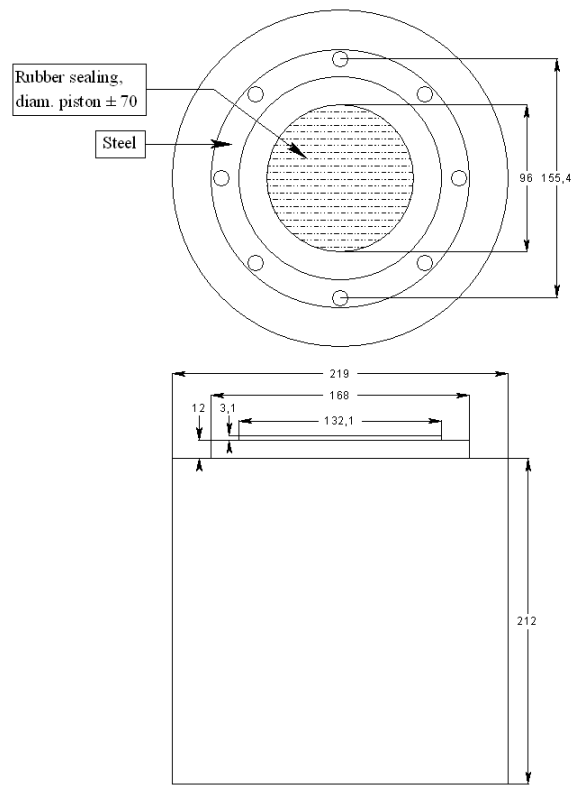

Figure 1. LFPX-4 Projector: top and side view, with global dimensions in mm.



Figure 2. LFPX-4 Projector.

Sensors

For the pressure measurements the PCB 116A02 high sensitivity, dynamic pressure transducers will be used. They have the following specifications:

- measurement range 1000 psi ($\approx 7 \times 10^6$ Pa),
- maximum pressure 5000 psi ($\approx 3.5 \times 10^7$ Pa),
- resolution 0.002 psi (≈ 14 Pa),
- nominal sensitivity 8 pC/psi ($\approx 1 \times 10^{-3}$ pC/Pa),
- rise time 5.0 μ s
- resonant frequency 125 kHz

Via a charge amplifier the signal will be amplified and converted to voltage, which can be recorded with the B&K PULSE frequency analyzer.

To verify whether the pressure is about equal everywhere, 4 transducers will be installed equally spaced in the circumference of the housing wall. Via special adapters they can be 'flush mounted' in the side wall. The screw thread will be included in the housing design.

The velocity sensor, i.e. accelerometer in this case, will be rigidly glued on top of the rubber sealing of the moving projector piston. An Endevco 50 piezoelectric accelerometer will be used:

- Measurement range ± 40 g (≈ 400 m/s²)
- resolution ≤ 0.001 g (rms)
- Nominal sensitivity 50 mV/g (≈ 5 mV/(m/s²))
- resonance frequency 10 kHz
- weight 3.8 gr

This transducer has an integrated amplifier that can be fed directly by the B&K PULSE analyzer. The sensor itself is hermetically sealed and thus water tight. It has a 3m long, already attached signal cable. However, the connection to the sensor itself was not water tight. It is made water tight with a special resin and the performance of the sensor is tested in a purpose-made experimental setup, as shown in the figure below. The accelerometer is placed in a cup on a shaker and the frequency response (FRF) was checked for 2 cases: the cup without water and filled with water.

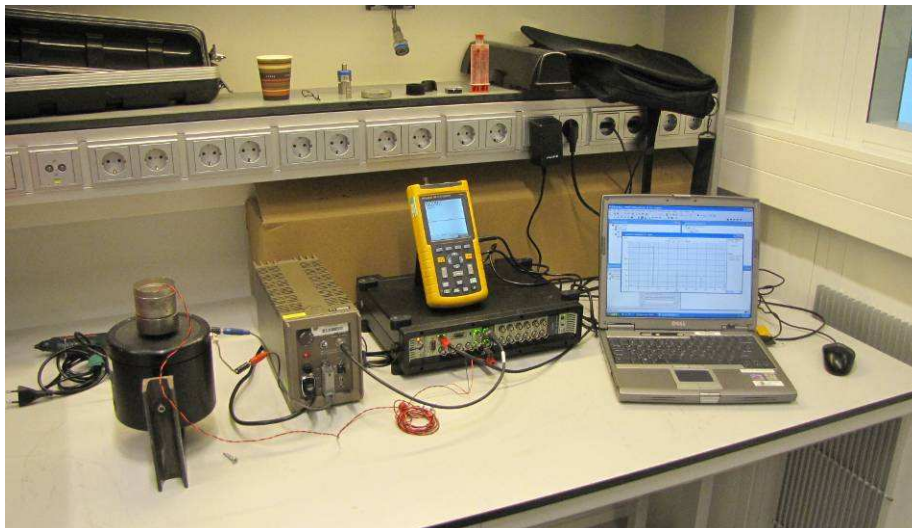

Figure 3. Experimental setup for testing water-resistant accelerometer.

In the larvae chamber/housing a 2.5 mm cable transit will be made. After installation of the signal cable, the remaining opening in the transit will be sealed with high resistive glue/resin. Finally a screwable connector will be used to connect the transducer cable to the analyzer.

Housing

The housing consists of a cylindrical side wall and a top cover. As can be seen in figure 1 and 2 the projector has a 3mm thick steel ring that clamps the rubber sealing. This ring is used to centre the side wall above the projector piston. A 160 mm high and 28 mm thick tube, with a 110 mm inner diameter, will be placed on top of this ring; this will serve as the chamber side wall. The tube is made from stainless steel type 316, which is very suitable for salt water applications. The stiffness of the wall is in the order of magnitude of 1×10^{10} N/m in longitudinal direction and 1×10^{11} N/m in radial direction

The tube will be mounted on the projector with special studs (projector has UNC thread) and nuts, for which a cut-away (mounting hole) is made in the tube. In figure 1 the radius of the 8 holes in the projector was already given (155.4 mm). Special gasket material will be placed underneath the tube for final sealing. A 3D sketch of the tube is given in figure 4, where also some specific positions for the transducers etc. are indicated.

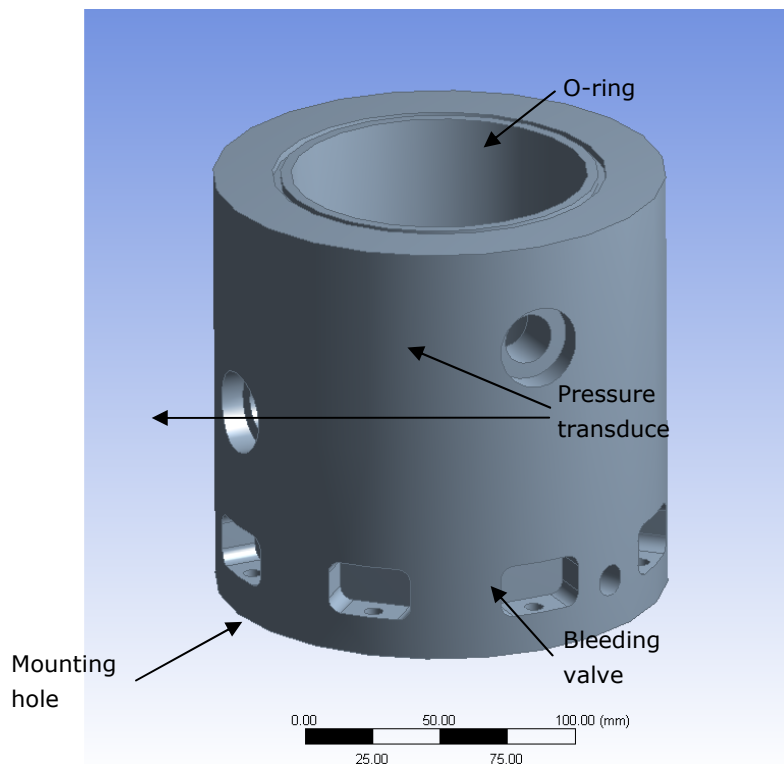

Figure 4. 3D sketch of the housing side wall.

The central part of the top cover will be made from 35 mm thick circular plate made of transparent PMMA, also called Perspex. The outer part of the cover will be made from aluminium. This aluminium outer part makes the cover stiffer and screwable on the side wall of the setup. The bending stiffness of the top cover is about 1×10^9 N/m. To be able to quickly mount the cover on the side wall, this will be a screwed connection, with female thread on the cover and male thread on the side wall. A rubber o-ring in a groove on top of the side wall has to ensure the final sealing between the 2 parts. A 3D sketch of the cover and total the assembled situation is shown in the figures below.

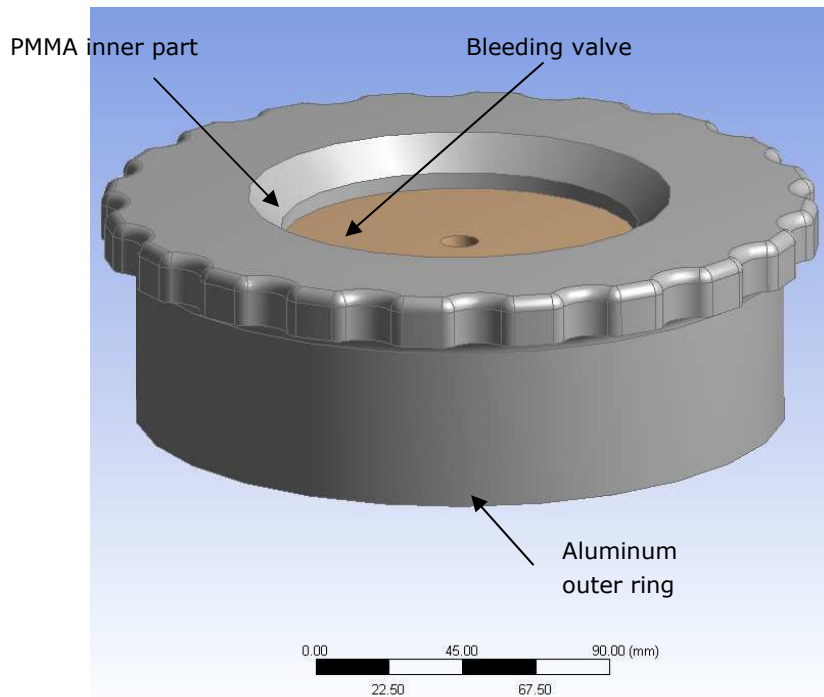

Figure 5. 3D sketch of the top cover.

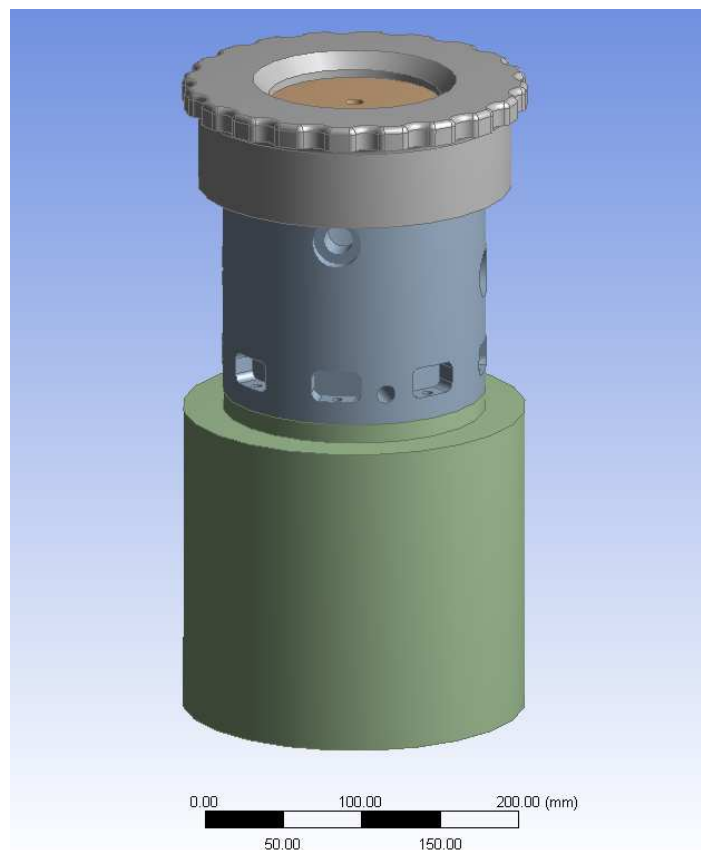

Figure 6. 3D sketch of complete assembly, including projector.

The housing is designed in such a way that all the resonance frequencies are higher than 1000 Hz. The first 6 resonance frequencies of the housing (side wall plus cover) are given in the table below. Since the setup is not exactly axial symmetrical due to the mounting holes etc., the resonance frequencies of each set of 2 accompanying modes differ slightly. A few mode shape characteristic examples are given in figure 7 and 8.

Table 1. First 6 resonance frequencies experimental setup.

Mode no.	Frequency [Hz]	Mode type
1	1936	1 st order axial bending
2	1975	1 st order axial bending
3	3235	1 st order torsional
4	4050	2 nd order circumferential bending ('ovaling')
5	4063	2 nd order circumferential bending ('ovaling')
6	4162	1 st order bending PMMA part of cover

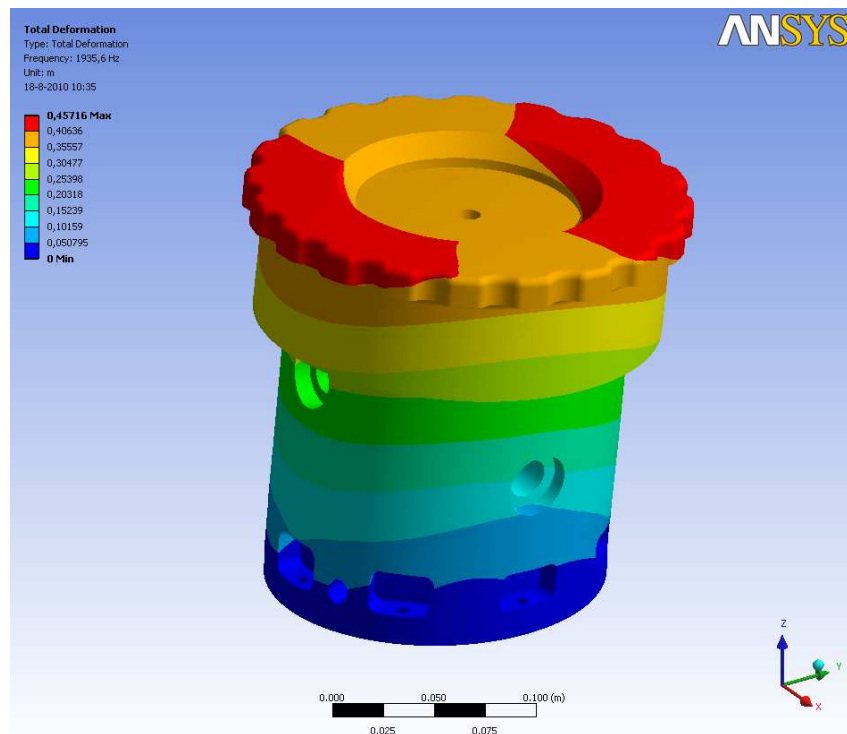

Figure 7. 1st order axial bending mode of the assembled test setup at 1936 Hz.

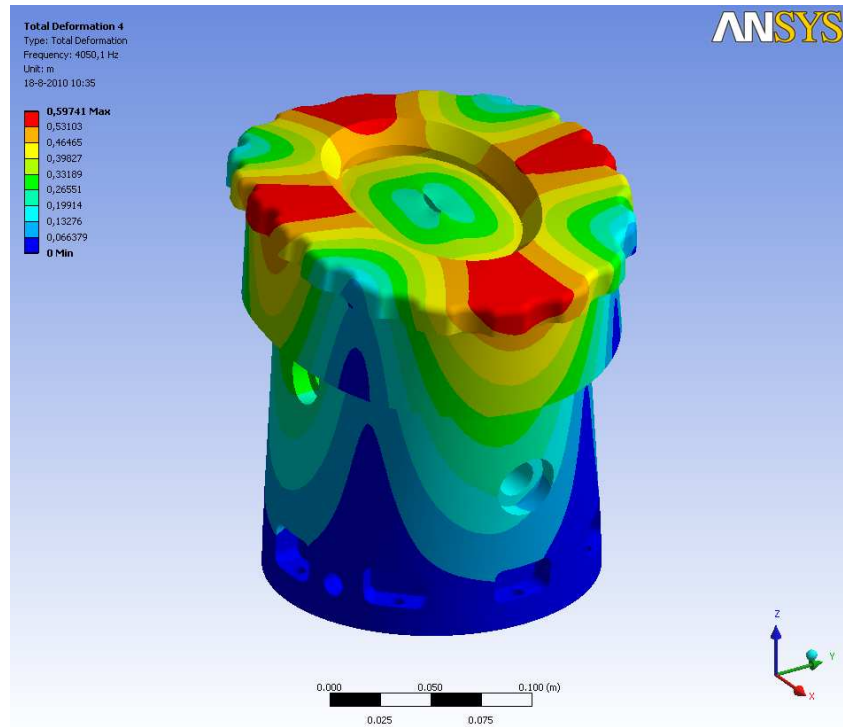

Figure 8. 2nd order circumferential bending (‘ovaling’) mode of the assembled test setup at 4050 Hz.

Finally a 1.52 L cylindrical volume is obtained. The 1st resonance frequency of this water filled volume occurs at about 11 kHz, which is also high above the frequency range of interest. The equivalent ‘stiffness’ of the water column is approximately 1.3×10^8 N/m, which is considerably lower than the stiffness of all the housing parts.

Air bleeding system

All the parts will be fabricated in such a way that they will fit close to each other, without any remaining hollow spaces, etc. The side wall and PMMA part of the cover will be polished, so as little as possible air bubbles will ‘stick’ to them.

At the bottom of the side wall and in the middle of the cover a valve will be placed. Via these valves the remaining air can be removed, after the cover has been closed. The underside of the cover will be turned off slantwise (2 mm) to the middle cover, so the valve is always located at the highest point of the chamber. High quality Stainless steel Festo valves and quick push-in couplings will be used, which have the advantage that the cover can be screwed on to the housing side wall without winding the connection hose. They are also suited to withstand a water pressure up to 10 bar if needed.

A bin filled with about 2 L of sea water and placed at an adjustable stand higher than the rest of the setup, will provide the small amount of overpressure that is needed to release the remaining air underneath the cover valve. A 3D sketch of the installed bleeding system is shown in figure 9, which also shows the total setup on its supports. Underneath the supports adjustable feet with vibration isolators are mounted.

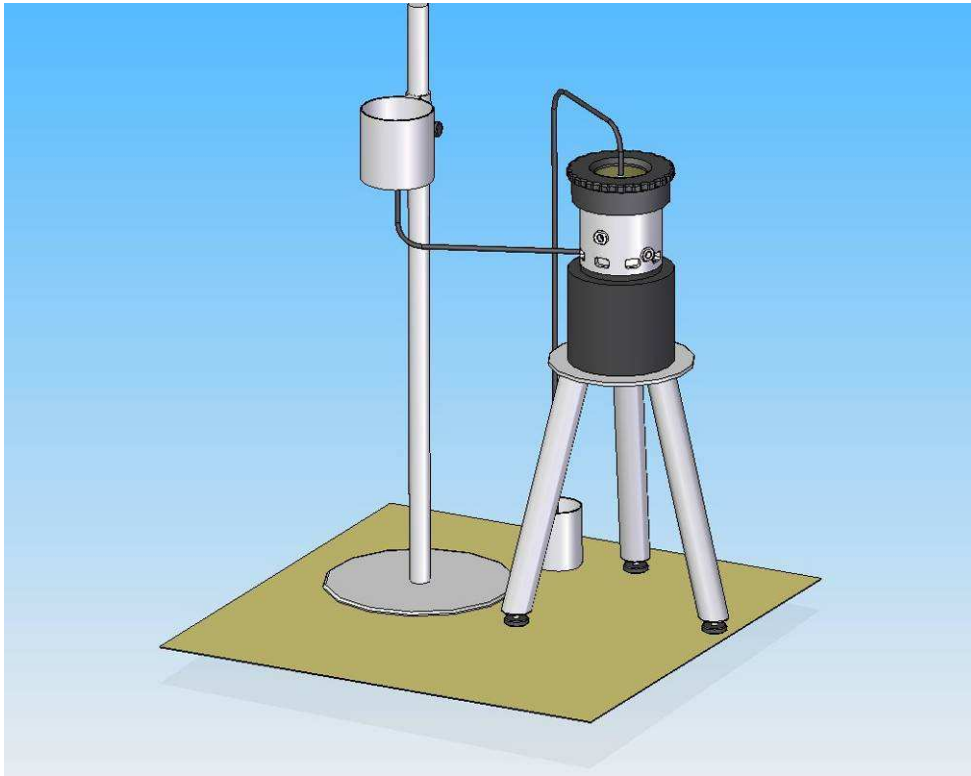

Figure 9. Complete experimental test setup, including air bleeding system and supports.

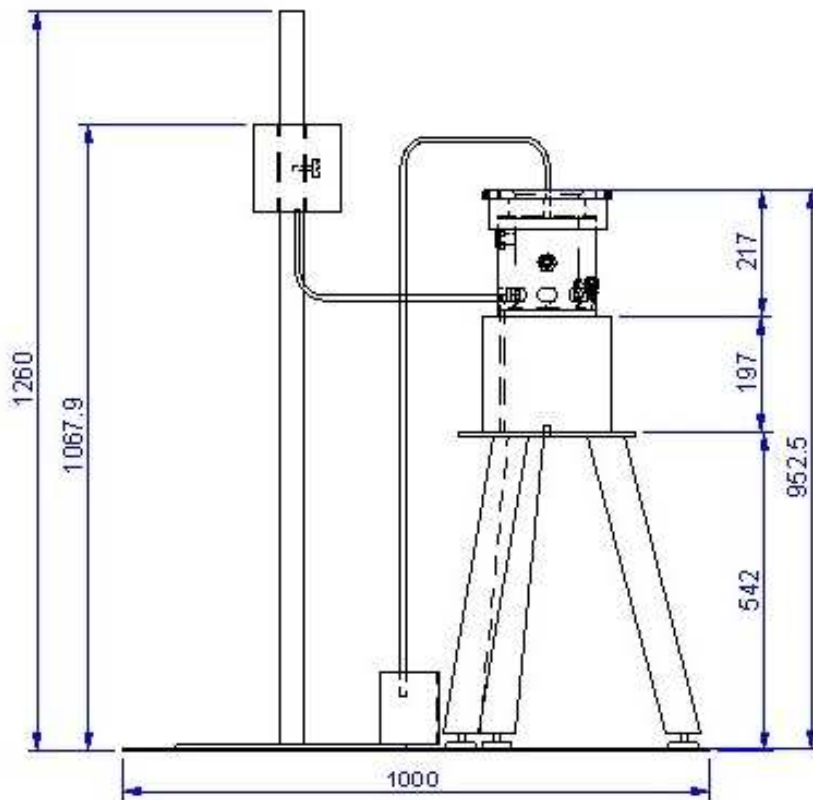
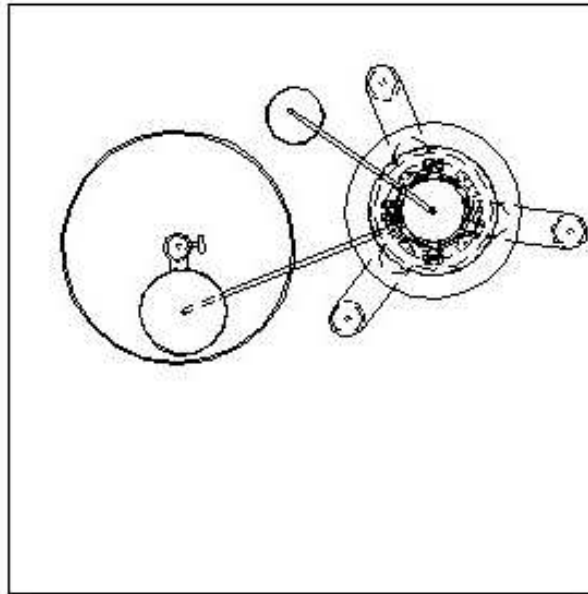

Figure 10. Possible global dimensions of the complete experimental test setup

Appendix C. TNO memo 3



TNO Science and Industry

Memorandum

From

P.J.G. van Beek

Subject

The effect of piling noise on the survival of fish larvae - pilot experiments - memo-3: Testing of experimental setup

Date

20 December 2010

1 Introduction

This is the third memorandum in the preparation of pilot experiments for determining the effect of underwater noise due to pile driving on the survival of fish larvae. It describes the performance validation test of the experimental test setup for testing the response of fish larvae to artificial piling noise. In the 2nd memo a practical design was made, which was based on the 'larvaebrator' concept of the 1st memo of the project 'testing of the tube'.

In memo 2 the design phase of the experimental setup was divided into different items, from which the following 2 are covered in the current memo:

- fabrication/assembly,
- performance validation.

2 Fabrication & assembly

First of all it has to be noticed that after the preparation of memo 2, an extra specification has been added to the design requirements of the test setup: for both the velocity and pressure source test conditions, it should be possible to introduce a static overpressure inside chamber, varying between about 0.2 and a maximum of 3 bar. This overpressure should better simulate the variety of underwater conditions at the range of depths at which the larvae are situated. It is obvious that this has some consequences for the original design.

For the velocity source test now the top cover also is installed and via a precise pressure regulator a static overpressure can be introduced. For this case the lower bleeding valve is already closed at the beginning of the test. When the required pressure is achieved, the upper bleeding valve also is closed.

At the same time exactly the same pressure also is applied to the compensation chamber on the backside of the projector. This ensures that the piston of the projector remains at its original position in case of no excitation signal. To achieve this, both chambers are connected to the same static pressure source (air compressor in this case) via a T-joint in the tube between the chambers and the source. Then the pressure is automatically levelled. The compensation chamber of the projector is equipped with a so-called Schrader valve, which is also used for vehicle tyres. Note that this is a one-way valve that automatically holds to the maximal applied pressure. This means that when the test condition is returned to a lower static pressure, first the compressed air in the compensation chamber has to be released by hand. This can be done easily with special tool that opens the valve in the other direction. After that the required static pressure can be applied. A schematic overview of the connections, valves, etc. is given in figure 1.

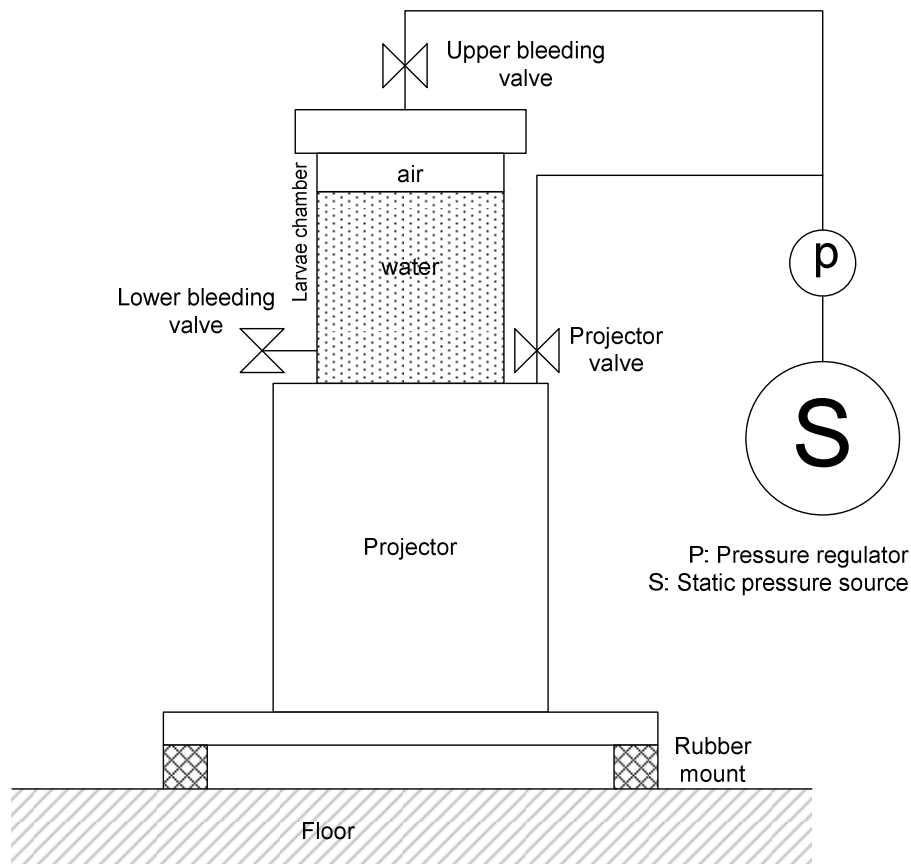

Figure 1. Schematic overview static pressure regulation in case of velocity excitation signal.

In case of the dynamic pressure signal test condition in principle the application of the overpressure is the same as in the velocity test condition. However, in this case the test chamber must be fully filled with water. Therefore the static air pressure is applied to another reservoir that is partially filled with water. This reservoir is connected to the lower bleeding valve of the test chamber. In this case first a small overpressure is applied to the reservoir. When all the remaining air has left the larvae test chamber via a separate small tube that is connected to the upper bleeding valve, this valve is closed. After that, when the required static pressure is achieved, the lower bleeding valve is also closed. A schematic overview of the static pressure regulation is given in figure 2. Finally the actual testing can be started.

After memo 2 it was also decided that it is better to place the projector plus larvae chamber directly on decoupling mounts on the floor, instead of the using the tripod supports. These relatively 'flexible' supports might cause extra, unwanted vibrations i.e. resonances in the measured response signals. Therefore the projector is mounted on a 30 mm thick steel plate of 400 x 400 mm. Underneath the plate on each corner a rubber mount is placed with a Shore-A hardness of 50, which results in a resonance frequency of the complete setup of about 15 Hz. A 3D impression of the updated design is given in figure 3, together with a side view in figure 4.

The complete manufactured and installed laboratory setup is shown in figure 5

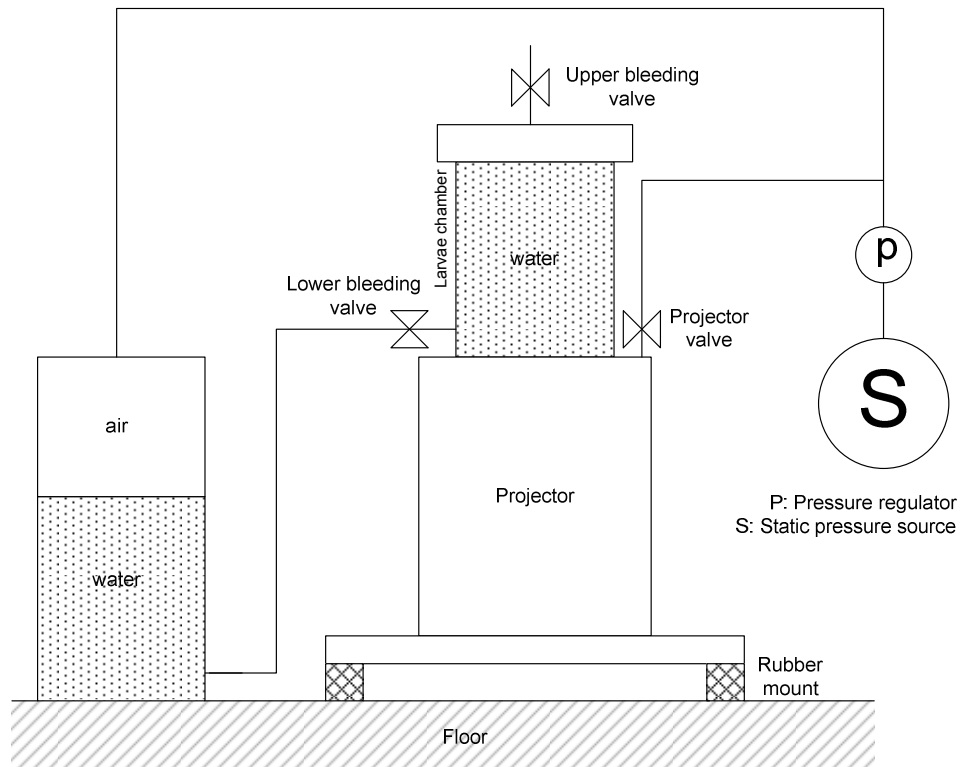

Figure 2. Schematic overview static pressure regulation in case of pressure excitation signal.

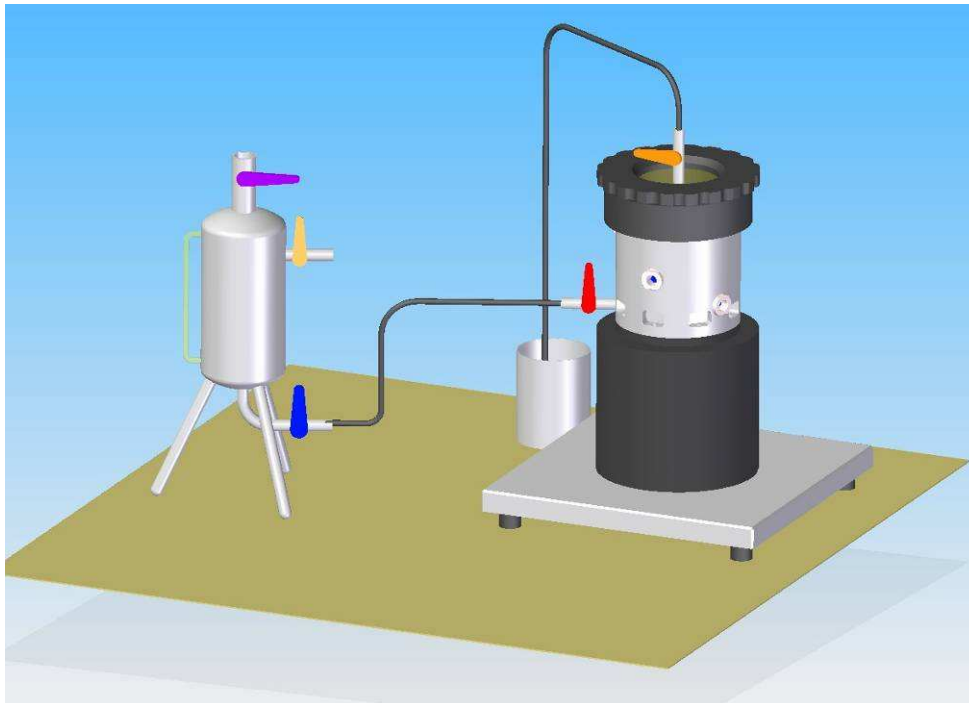

Figure 3. A 3D impression of the updated experimental test setup.

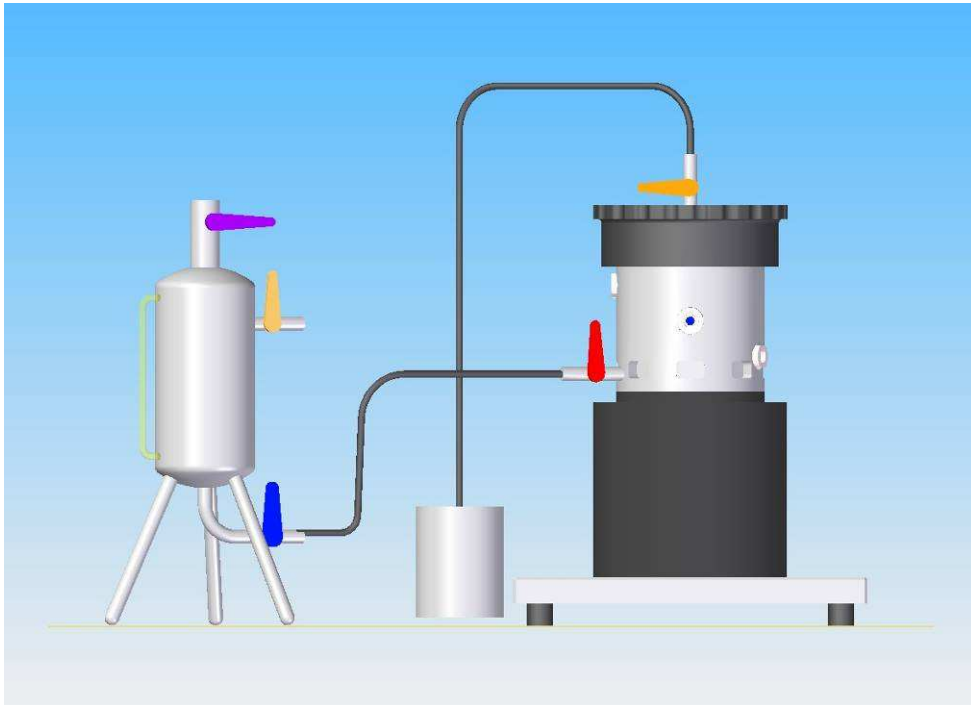

Figure 4. Side view of the updated experimental test setup.

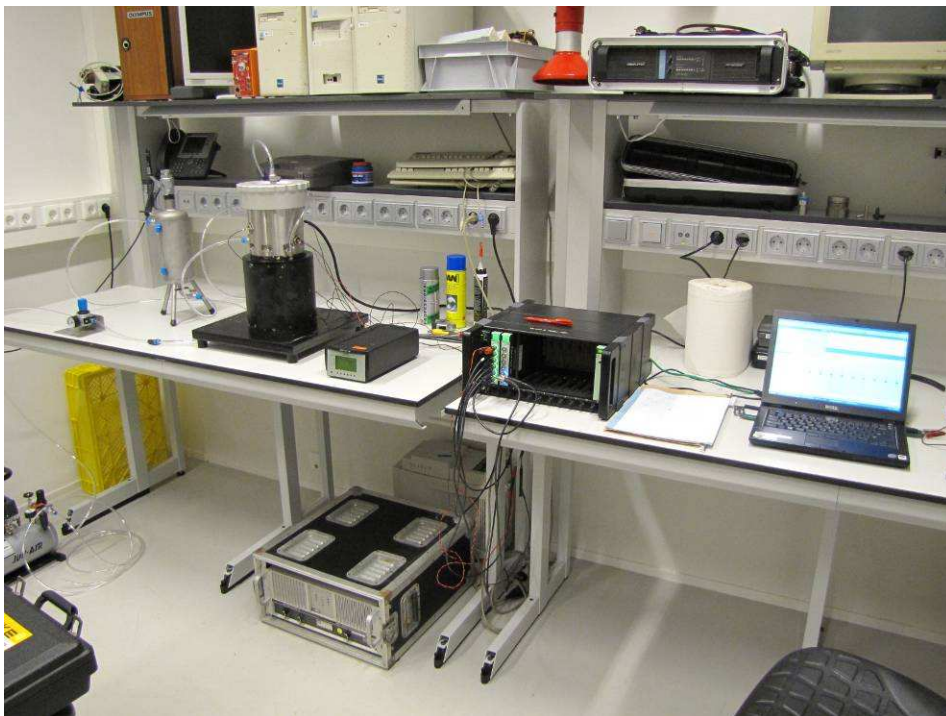

Figure 5. Overview of the laboratory test setup, including measurement equipment.



Figure 6. Laboratory test setup: projector and larvae chamber (right), reservoir (middle), pressure regulator (left)

3 Performance validation

In memo 1 already an example of a piling pressure signal was shown. A similar signal is used for both pressure and velocity excitation. A real, measured piling pressure signal (measured at 100 m from a pile at the OWEZ wind farm) is filtered between about 20 and 3000 Hz with a 3rd order Butterworth filter and tapered to zero around the signal with a Tukey window. Finally it is normalized to a signal with a maximum of 1 and converted to a 16 bit .wav file, which can be used as an output signal for the generator and thus as input signal for the projector amplifier. The B&K Pulse LanXI analyzer has an integrated signal generator, so the output signal and measured velocity and pressure signals are always synchronized. An example of a normalized excitation signal is given in figure 7. The signal can be repeated as many times as required. Initially for the performance validation the same signal is used for both pressure and velocity excitation.

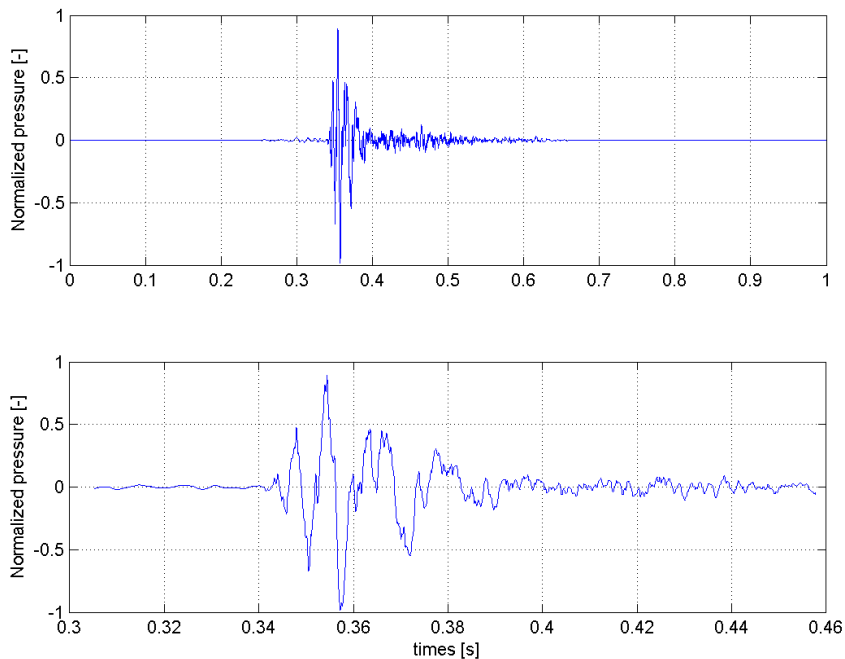

Figure 7. Normalized excitation: complete signal (upper) and zoomed (lower).

4 Piling noise signals

As explained in the first memo, the main characteristics of the piling noise pulses in connection with the potential effects are the peak level and the integrated exposure level of the sound pressure and acoustic particle velocity. In the selection of the signals for the controlled exposure, care is taken that the peak and integrated exposure levels have the correct ratio, so that the signals have the correct ‘impulsiveness’. It is unknown which other properties of the signals might have an effect. Therefore it is decided to use actually recorded piling noise instead of synthetic signals. However, recorded pulses are not available for all the specific distances that were selected for this exposure study. Therefore it was decided to use recorded signals that are scaled to the correct peak and/or exposure levels at the required distance. Hence, the signals to which the larvae will be exposed are characteristic for piling underwater noise, with the correct peak and integrated exposure level, instead of actually recorded signals at the various distances. In real life, the actual wave shape of piling noise will vary a lot, due to variations in pile, hammer and environment, but the characteristic parameters will be similar to the ones chosen for this study.

Two measured signals are selected, one at 100 m and one at 800 m from a pile at the OWEZ wind farm. The amplitude will be adapted to the various distances according to a $15\log_{10}(\text{distance})$ scaling (i.e. 4.5 dB decrease for each doubling of the distance), according to the following table.

Table 1.

distance	peak pressure	SEL	peak velocity	integrated velocity	wav-file
m	dB re 1 μPa^2	dB re 1 $\mu\text{Pa}^2\text{s}$	dB re 1 $(\text{nm/s})^2$	dB re 1 $(\text{nm/s})^2\text{s}$	
100	210	188	147	124	pressure_100m_filter.wav
200	205	183	142	119	pressure_100m_filter.wav
400	201	179	138	115	pressure_100m_filter.wav
800	196	174	133	110	pressure_800m_filter.wav
1600	192	170	129	106	pressure_800m_filter.wav
3200	187	165	124	101	pressure_800m_filter.wav

Note that the applied distance scaling is not generally applicable for all piling locations, because this will depend on the actual local propagation conditions. However, the main aim of the proposed controlled exposure study is to obtain dose-response relationships, where the dose is quantified according to the four parameters in the above table.

5 Test results

The experimental set-up (filled with clean tap water) was tested at the maximum achievable acoustic level in four different configurations:

- c* Velocity excitation at 0 bar overpressure
- d* Velocity excitation at 2 bar overpressure
- e* Pressure excitation at 0 bar overpressure
- f* Pressure excitation at 2 bar overpressure

In each configuration the modified wav-file of the 100 m recording was sent to the projector at a level close to the maximum allowable level for the projector. The resulting acoustic signals in the chamber were measured by the accelerometer on the piston and by the four pressure transducers in the wall of the chamber.

The results are shown in the following two figures. Note that the pressure sensors are numbered from bottom (close to the piston) to top.

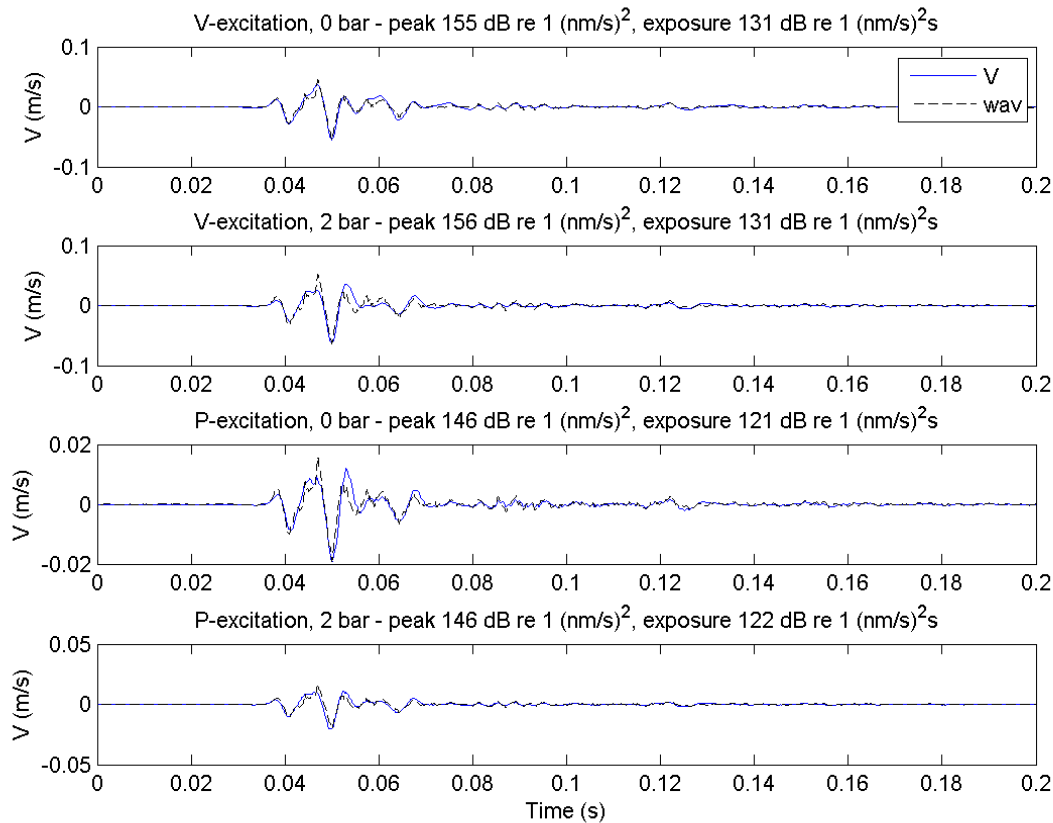

Figure 8. The velocity of the piston of the projector for the four different excitation configurations. The black dashed line is the waveform of the wav-file, scaled to match the peak level of the measured velocity (blue line). The header gives the peak and integrated particle velocity levels that were obtained in these tests. These may be considered the maximum achievable levels.

It can be seen that the piston reproduces the original recorded wav-files quite accurately. In the configurations with pressure excitation, the velocity levels are substantially lower than for velocity excitation.

The maximum achievable velocity levels for velocity excitation are about 8 dB higher than required for this study (see table 1).

In case of pressure excitation, the piston velocity level is relatively high, probably due to remaining flexibility (air/membrane) in the chamber. The observed pressure to velocity ratio is actually close to the ratio in a plane wave in unbound water. So the present set-up does not produce a pure pressure excitation.

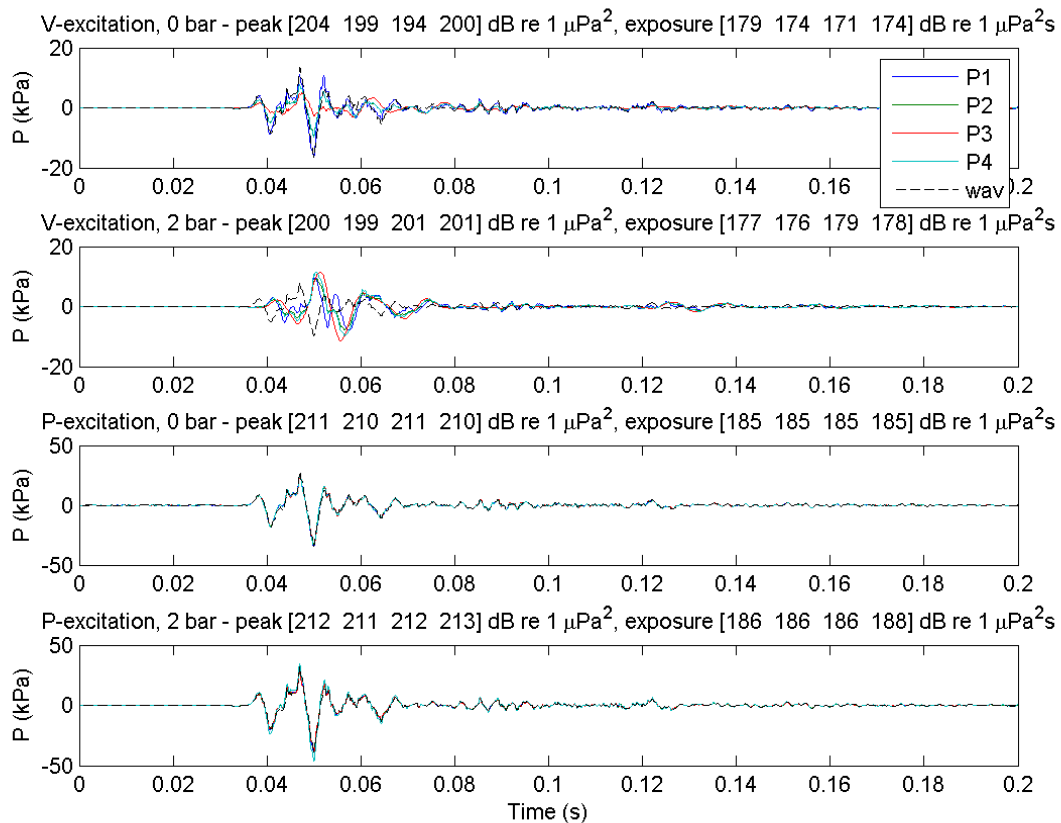

Figure 9. The sound pressure at the four sensors in the larvaebibrator chamber for the four different excitation configurations. The black dashed line is the waveform of the wav-file, scaled to match the peak level of the measured pressure at sensor 2. The header gives the peak and integrated pressure levels that were obtained in these tests. These may be considered the maximum achievable levels

It can be seen that the sound field reproduces the original recorded wav-files quite accurately in case of pressure excitation (the two lower figures). The pressure distribution in the chamber is very homogeneous in that configuration.

The maximum achievable pressure levels for pressure excitation are about 1-2 dB higher than required for this study (see table 1).

In case of maximum velocity excitation, the pressure levels are 8-13 dB lower than in case of pressure excitation. Because the required velocity levels are about 8 dB lower than the maximum velocity levels, it follows that the pressure levels in case of velocity excitation are negligibly small, compared to the levels for pressure excitation.

So the two different excitation types create two very different exposures:

- *Predominant velocity excitation*
- *Pressure and velocity excitation at a ratio in the same order of magnitude as the ratio in acoustic waves in unbound water*

Figures 10 and 11 show that the main characteristics of the frequency spectra of pressure and velocity are reproduced to an acceptable level.

We conclude that the set-up is ready for the larvae exposure tests.

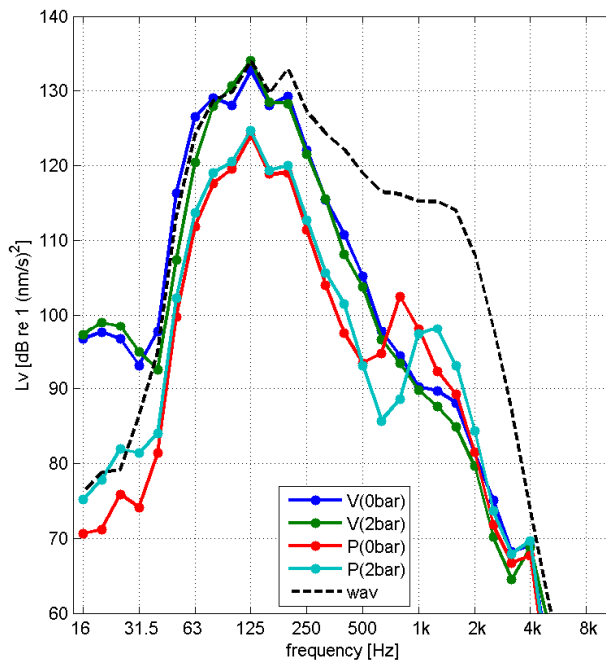

Figure 10. velocity spectrum (1/3-octave bands) for the four configuration, compared with the spectrum of the wav-file, scaled to match the peak level of the measured velocity

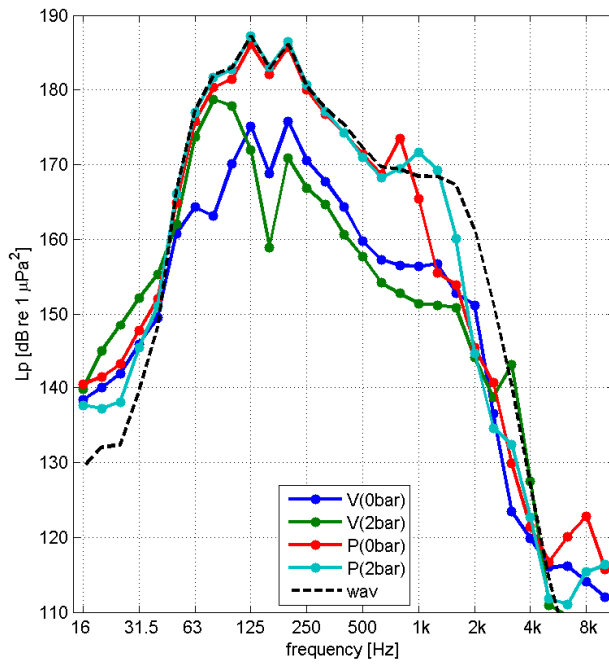

Figure 11. pressure spectrum of sensor 2 (1/3-octave bands) for the four configuration, compared with the spectrum of the wav-file, scaled to match the peak level of the measured pressure

Appendix D. TNO memo 4



TNO Science and Industry

Memorandum

From

P.J.G. van Beek

Subject

The effect of piling noise on the survival of fish larvae - pilot experiments - memo-4: First Trial at Imares

Date

3 November 2010

1 Introduction

This is the fourth memorandum of the pilot experiments for determining the effect of underwater noise due to pile driving on the survival of fish larvae. At October 6th the first trial of experiments with real fish larvae was carried out at IMARES in IJmuiden. In total 12 valid measurements with piling excitation were performed, see table 1.

Table 1. Overview of the first day pilot experiments trial with real larvae.

Measurement no.	Excitation type	Larvae container no.	Simulated distance	Number of strokes
2	velocity	4	800	1
3	velocity	5	800	1
4	velocity	6	100	1
5	velocity	7	100	1
6	velocity	8	100	100
7	velocity	9	100	100
8	pressure	12	800	1
9	pressure	13	800	1
10	pressure	14	100	1
11	pressure	15	100	1
12	pressure	16	100	50
13	pressure	17	100	50

As can be seen in table 1, each experiment was carried out twice. Each container consisted of 25 larvae (batch). Furthermore first two reference batches (container no. 1 and 2) of larvae were exposed only to the static pressure of 0.5 bar. During the day, actually in between the velocity and the pressure excitation, the static test was repeated with two other batches (container no. 10 and 11). This 0.5 bar static pressure is used for all the measurements during trial 1. Note that in practice the pressure excitation in fact is a combined pressure and velocity excitation.

2 Acoustic results Trial 1 experiments

The time signal of the (normalized) piling excitation is given in figure 1. The time signals of the resulting, measured velocity at the piston are given in figure 2 and 3. Figure 2 shows the measured velocities due to velocity excitation a respectively 800m and 100m (latter with 1 stroke and 100 strokes). For the tests with 100 strokes one representative stroke is used for further analysis (almost no difference between individual

strokes). In figure 3 the measured velocities due to pressure excitation at respectively 800m and 100m (latter with 1 and 50 strokes) are given. The peak and SEL levels are also shown in the figures. The accompanying measured pressures are given in figure 4 and 5. The spectra are given in figure 6 and 7. All results correspond very well to the requested levels from table 1 in memo 3, which is repeated here [1]:

Table 2. Expected velocity and pressure levels at different distances due to piling excitation.

distance	peak pressure	SEL	peak velocity	integrated velocity
m	dB re 1 μPa^2	dB re 1 $\mu\text{Pa}^2\text{s}$	dB re 1 $(\text{nm/s})^2$	dB re 1 $(\text{nm/s})^2\text{s}$
100	210	188	147	124
200	205	183	142	119
400	201	179	138	115
800	196	174	133	110
1600	192	170	129	106
3200	187	165	124	101

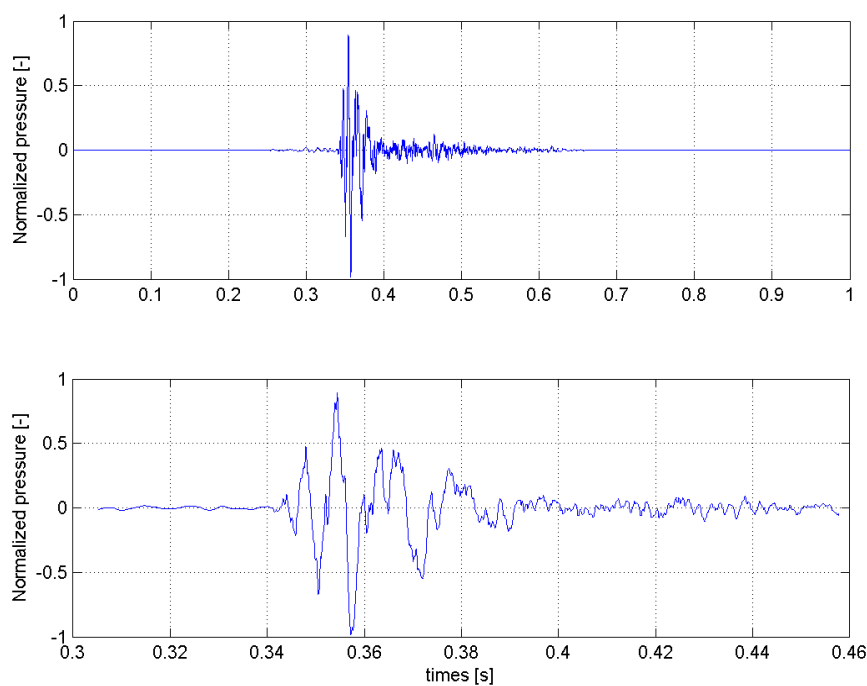

Figure 1. Normalized piling excitation at 100m: complete signal (upper) and zoomed (lower).

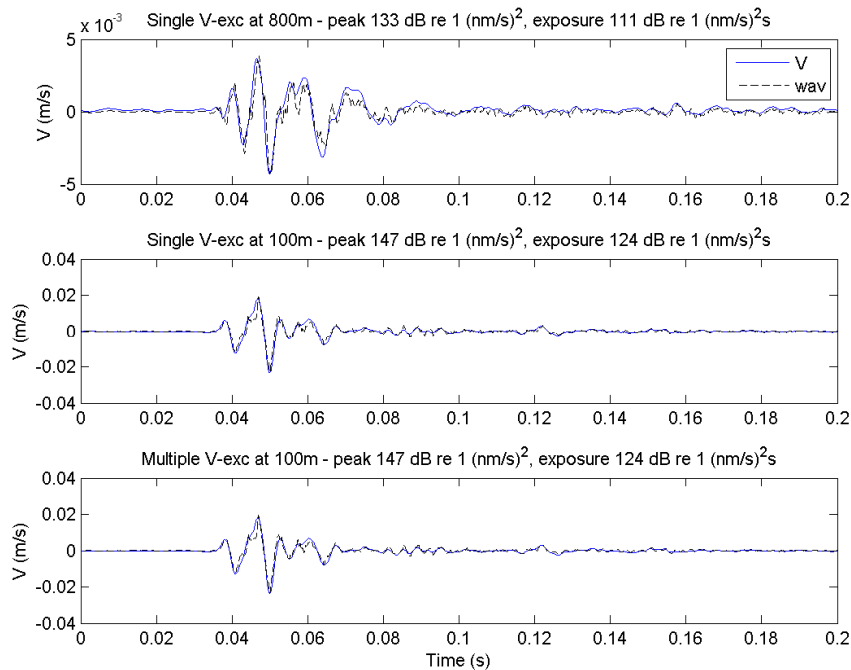

Figure 2. Measured velocity at 800m with one stroke (upper), 100m with one stroke (middle) and 100m with 100 strokes (lower), due to velocity excitation.

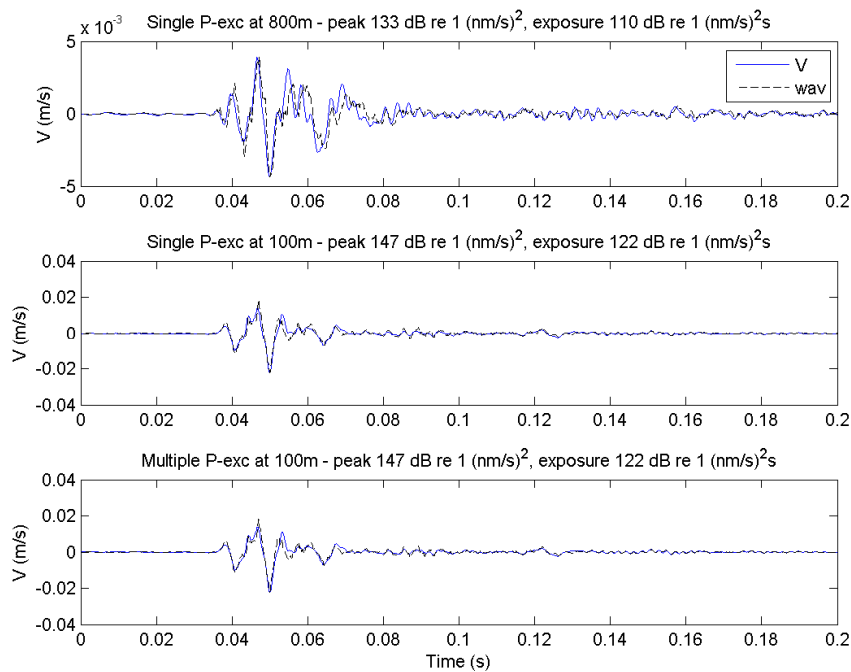

Figure 3. Measured velocity at 800m with one stroke (upper), 100m with one stroke (middle) and 100m with 50 strokes (lower), due to pressure excitation.

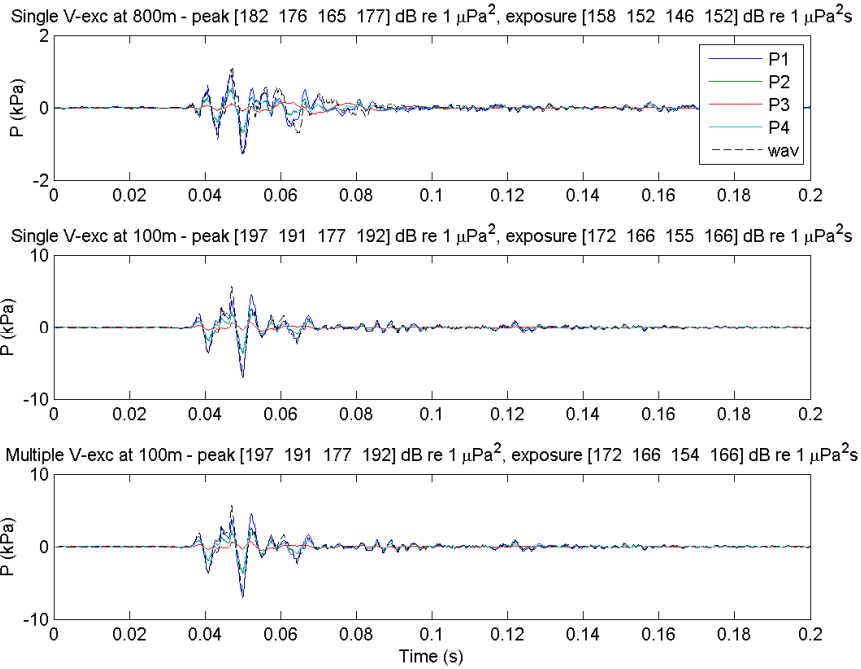

Figure 4. Measured pressures at 800m with one stroke (upper), 100m with one stroke (middle) and 100m with 100 strokes (lower), due to velocity excitation.

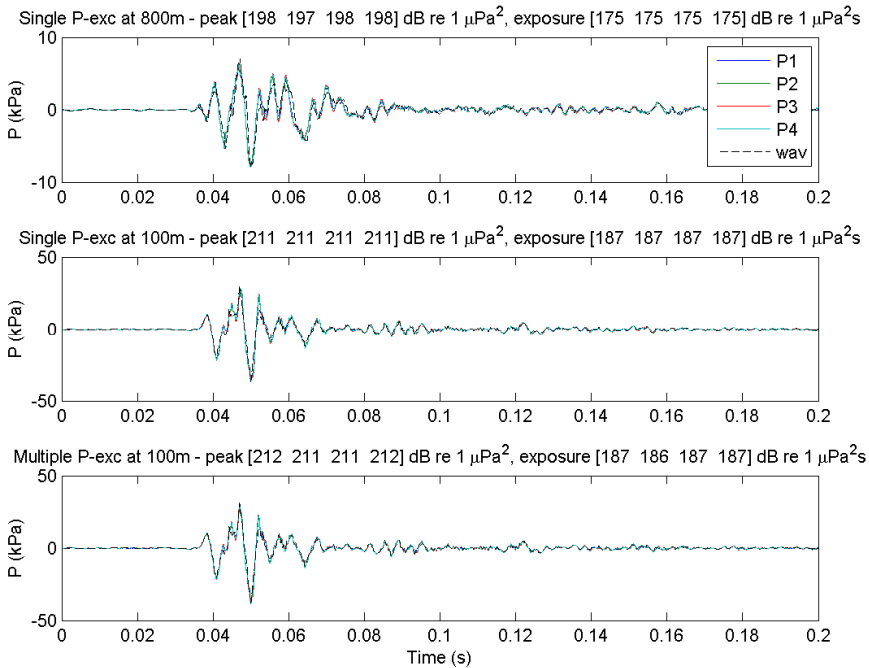

Figure 5. Measured pressures at 800m with one stroke (upper), 100m with one stroke (middle) and 100m with 50 strokes (lower), due to pressure excitation.

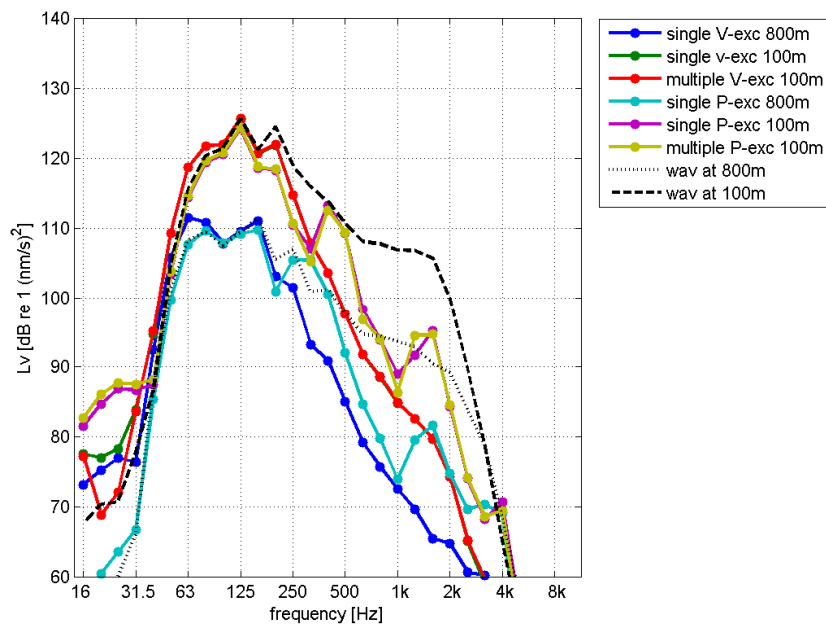

Figure 6. Velocity spectra of the time signals as given in figure 2 and 3, including the excitation wav signal at 100m and 800m (reference).

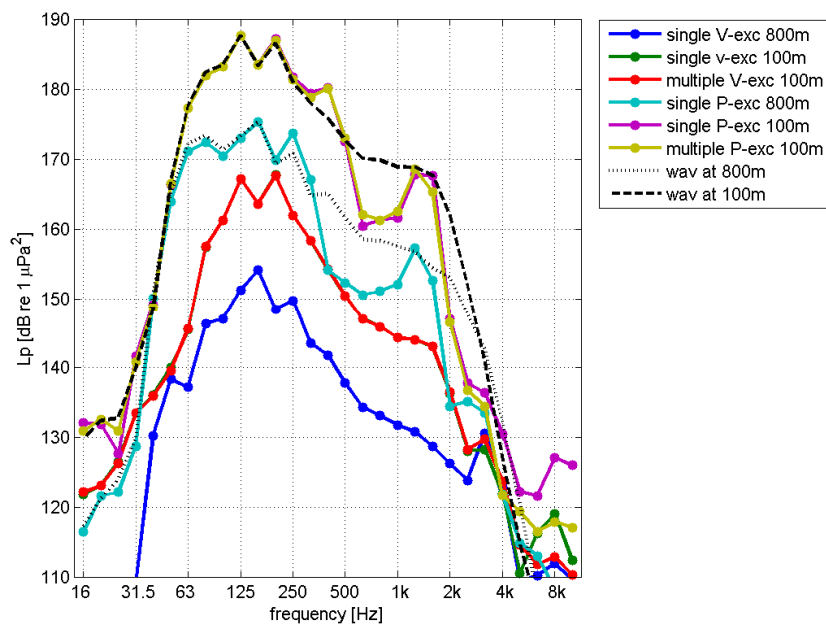

Figure 7. Pressure spectra of the time signals as given in figure 4 and 5, including the excitation wav signal at 100m and 800m (reference).

Appendix E. TNO memo 5



TNO Science and Industry

Memorandum

From

P.W. Wessels

Subject

The effect of piling noise on the survival of fish larvae - experiments - memo-5: Trials 1 to 3 at Imares.

Date

31 March 2011

1. Introduction

This is the 5th memorandum of the experiments for determining the effect of underwater noise due to pile driving on the survival of fish larvae. In this memorandum the results of trial 1 to 3 will be shown. Experiments were performed on the 6th October, the 26th October and on the 7th of December 2010.

1.1 Trial 1, 6th of October 2010

The first trial, containing a total of 13 measurements, was performed on the 6th of October 2010, see Table 1. All measurements of trial 1 were carried out at a static pressure of 0,5 bar.

Table 1. Overview of the experiments of trial 1, with static pressure of 0,5 bar.

Excitation type	distance	strokes	Experiment id	Measurement id
Velocity	100	1	3	1
Velocity	800	1	4,5	2,3
Velocity	100	1	6,7	4,5
Velocity	100	100	8,9	6,7
Pressure	800	1	12,13	8,9
Pressure	100	1	14,15	10,11
Pressure	100	50	16,17	12,13

1.2 Trial 2, 26th of October

The second trial, containing a total of 19 measurements, was performed on the 26th of October 2010, see Table 2 and Table 3. Only the first 3 measurements were performed at a static pressure of 2 bar. The remaining measurements were performed at a static pressure of 0 bar.

Table 2. Overview of the experiments of trial 2, with static pressure of 2 bar.

Excitation type	distance	strokes	Experiment id	Measurement id
Pressure	100	1	1	1
Velocity	100	100	2	2
Velocity	200	70	4	3

Table 3. Overview of the experiments of trial 2, with static pressure 0 bar.

Excitation type	distance	strokes	Experiment id	Measurement id
Pressure	100	50	7,12,16,23	5,9,13,18
Pressure	200	200	5,13,15,24	4,10,12,19
Velocity	100	100	9,14,17,20	7,11,14,16
Velocity	200	200	8,10,19,22	6,8,15,17

1.3 Trial 3, 7th of December

The third trial, containing a total of 25 measurements was performed on the 7th of December 2010, see Table 4. All measurements of trial 3 were carried out at a static pressure of 0 bar.

Table 4. Overview of the experiments of trial 3, with static pressure 0 bar.

Excitation type	distance	strokes	Experiment id	Measurement id
Pressure	100	1	1	1
Pressure	100	10	27,28,29,30	22,23,24,25
Pressure	100	100	4,10,16,18,24	3,9,13,15,19
Pressure	200	300	6,8,14,20,26	5,7,11,16,21
Velocity	100	100	2,7,15,21,23	2,6,12,17,18
Velocity	200	300	5,9,13,17,25	4,8,10,14,20

2. General aspects of the measurements

2.1 Format of the results

Every measurement consists of multiple (up to 300) strokes, with some variation around the reference stroke signal. Therefore in Table 8 to Table 15 the results of a statistical analysis of every measurement are shown.

Pressure excitation

The following values are shown: the mean value, standard deviation, minimum and the maximum of the peak pressure and SEL per measurement. This is done for the four pressure sensors. These four sensors should result in almost identical values, because a uniform pressure is assumed.

Velocity excitation

Just like for the pressure excitation, the shown values are: the mean value, standard deviation, minimum and the maximum of the peak velocity and the integrated velocity, for each measurement. In this case there is only one velocity sensor, at the piston of the sound source.

During some measurements a small air bubble caused the peak pressure and the SEL to vary, which results in a higher standard deviation. However the peak and SEL levels stay within an acceptable range.

Target

The targets that were set for each measurement can be found in Table 5 and Table 6.

Table 5. Targets pressure excitation.

Distance m	Peak pressure dB re 1 μ Pa ²	SEL dB re 1 μ Pa ² s
100	210	188
200	205	183
800	196	174

Table 6. Targets velocity excitation.

Distance m	Peak velocity dB re 1 (nm/s) ²	Integrated velocity dB re 1 (nm/s) ² s
100	147	124
200	142	119
800	133	110

Total values for integrated velocity and SEL

The values for integrated velocity and SEL considering the total number of strokes in one measurement, can be obtained by adding $10 \cdot 10 \log(N)$ to the mean values. Where N is the number of strokes per measurement. The resulting additions are given in Table 7.

Table 7. Additions to SEL and the integrated velocity

Number of strokes	Addition to the mean SEL value	Addition to the mean integrated velocity value
	dB re $1\mu\text{Pa}^2\text{s}$	dB re $1 (\text{nm/s})^2\text{s}$
1		0
10		10.0
50		17.0
70		18.5
100		20.0
200		23.0
300		24.8

3. Results of trial 1 through 3

The acoustic results of trial 1, 2 and 3 are shown in Table 8 to Table 15.

3.1 Validity of the measurements

Only two measurements are marked as invalid:

- Trial 3, velocity excitation, measurement 4 (Table 15)
- Trial 3, velocity excitation, measurement 10 (Table 15)

Both measurements appear to contain an excitation signal for 100 meter, while the excitation signal should set to 200 meter. All other measurements are considered to be valid.

3.2 Results Trial 1

The measurements of trial 1 are carried out with and without a static pressure. Here the results are shown, which were carried out at a static pressure of 0,5 bar.

Pressure excitation with static pressure 0,5 bar, see Table 8.

Table 8. Results overview of trial 1, pressure excitation with static pressure 0,5 bar.

Meas. id	Dist. [m]	Nr of strokes	Sensor	Peak pressure				SEL			
				[dB re 1 μPa^2]				[dB re 1 $\mu\text{Pa}^2\text{s}$]			
				mean	std	min	max	mean	std	min	max
8	800	1	p1	197,8	-	-	-	174,9	-	-	-
			p2	197,5	-	-	-	174,7	-	-	-
			p3	197,9	-	-	-	175,2	-	-	-
			p4	198,0	-	-	-	175,3	-	-	-
9	800	1	p1	198,5	-	-	-	174,3	-	-	-
			p2	198,4	-	-	-	173,9	-	-	-
			p3	199,1	-	-	-	174,3	-	-	-
			p4	198,9	-	-	-	174,4	-	-	-
10	100	1	p1	211,3	-	-	-	186,8	-	-	-
			p2	210,6	-	-	-	186,5	-	-	-
			p3	210,8	-	-	-	187,0	-	-	-
			p4	211,2	-	-	-	187,1	-	-	-
11	100	1	p1	211,7	-	-	-	186,6	-	-	-
			p2	211,3	-	-	-	186,2	-	-	-
			p3	211,8	-	-	-	186,6	-	-	-
			p4	211,9	-	-	-	186,8	-	-	-
12	100	50	p1	211,3	0,0785	211,2	211,6	186,7	0,0210	186,7	186,8
			p2	210,7	0,0944	210,6	211,2	186,4	0,0298	186,4	186,5
			p3	210,9	0,1196	210,8	211,5	186,8	0,0461	186,7	186,9
			p4	211,3	0,0980	211,1	211,7	187,0	0,0338	187,0	187,1
13	100	50	p1	211,2	0,0291	211,1	211,3	186,5	0,0059	186,5	186,6
			p2	210,7	0,0358	210,6	210,8	186,1	0,0080	186,1	186,2
			p3	210,9	0,0457	210,8	211,1	186,5	0,0108	186,4	186,5
			p4	211,2	0,0338	211,1	211,3	186,7	0,0081	186,7	186,8

Velocity excitation with static pressure 0,5 bar, see Table 9.

Table 9. Results overview of trial 1, velocity excitation with static pressure 0,5 bar.

Meas id	Dist. [m]	Nr of strokes	Sensor	Peak velocity [dB re 1 (nm/s) ²]				Integrated velocity [dB re 1 (nm/s) ² s]			
				mean	std	min	max	mean	std	min	max
1	100	1	v1	148,8	-	-	-	128,0	-	-	-
2	800	1	v1	132,4	-	-	-	111,6	-	-	-
3	800	1	v1	133,2	-	-	-	111,4	-	-	-
4	100	1	v1	147,4	-	-	-	123,5	-	-	-
5	100	1	v1	147,3	-	-	-	123,5	-	-	-
6	100	100	v1	147,4	0,0277	147,3	147,6	123,6	0,0091	123,5	123,6
7	100	100	v1	147,4	0,0349	147,3	147,6	123,6	0,0109	123,5	123,6

3.3 Results Trial 2,

Static pressure of 2 bar

The measurements of trial 2 are carried out with and without a static pressure. Here the results are shown, which were carried out at a static pressure of 2 bar.

Pressure excitation with static pressure 2 bar, see Table 10.

Table 10. Results overview of trial 2, pressure excitation with static pressure 2 bar.

Meas. id	Dist. [m]	Nr of strokes	Sensor	Peak pressure [dB re 1 μ Pa ²]	SEL [dB re 1 μ Pa ² s]
1	100	1	p1	211,2	186,0
			p2	210,7	185,5
			p3	211,1	185,9
			p4	212,9	187,9

Velocity excitation with static pressure 2 bar, see Table 11.

Table 11. Results overview of trial 2, velocity excitation with static pressure 2 bar.

Meas. Id	Dist. [m]	Nr of strokes	Sensor	Peak velocity [dB re 1 (nm/s) ²]				Integrated velocity [dB re 1 (nm/s) ² s]			
				mean	std	min	max	mean	std	min	max
2	100	100	v1	147,1	0,0176	147,1	147,2	122,5	0,0062	122,5	122,6
3	100	70	v1	142,4	0,1105	142,0	143,1	118,2	0,4492	118,1	121,9

Static pressure of 0 bar

The measurements of trial 2 are carried out/performed with and without a static pressure. Shown here are the results that were performed with a static pressure of 0 bar.

Pressure excitation with static pressure 0 bar, see Table 12.

Table 12. Results overview of trial 2, pressure excitation with static pressure 0 bar.

Meas. Id	Dist. [m]	Nr of strokes	Sensor	Peak pressure				SEL			
				[dB re 1 μPa^2]				[dB re 1 $\mu\text{Pa}^2\text{s}$]			
				mean	std	min	max	mean	std	min	max
5	100	50	p1	210,4	0,0277	210,4	210,5	185,8	0,0261	185,7	185,8
			p2	210,2	0,0366	210,1	210,2	185,8	0,0347	185,7	185,8
			p3	210,7	0,0465	210,6	210,7	186,5	0,0462	186,4	186,6
			p4	210,4	0,0433	210,3	210,5	186,0	0,0344	185,9	186,1
9	100	50	p1	210,1	0,0242	210,1	210,2	186,0	0,0613	185,8	186,0
			p2	209,8	0,0318	209,8	209,9	186,1	0,0917	185,9	186,2
			p3	210,8	0,2677	210,3	211,2	187,0	0,1121	186,7	187,1
			p4	210,1	0,0364	210,1	210,3	186,4	0,0892	186,2	186,5
13	100	50	p1	210,1	0,0267	210,1	210,2	185,9	0,0519	185,7	186,0
			p2	209,8	0,0362	209,8	209,9	186,0	0,0792	185,8	186,1
			p3	210,8	0,3351	210,3	211,5	187,1	0,1292	186,8	187,3
			p4	210,1	0,0335	210,0	210,2	186,2	0,0804	186,0	186,4
18	100	50	p1	210,2	0,0365	210,1	210,2	185,9	0,0621	185,8	186,0
			p2	209,9	0,0407	209,8	210,0	186,1	0,0991	185,8	186,2
			p3	210,4	0,0555	210,3	210,6	186,9	0,1113	186,5	187,0
			p4	210,1	0,0438	210,0	210,2	186,3	0,0933	186,0	186,4
4	200	200	p1	205,7	0,0325	205,7	205,9	180,8	0,0042	180,8	180,9
			p2	205,5	0,0359	205,5	205,8	180,7	0,0070	180,7	180,7
			p3	206,0	0,0447	206,0	206,3	181,2	0,0094	181,2	181,3
			p4	205,8	0,0405	205,7	206,1	180,9	0,0067	180,9	180,9
10	200	200	p1	206,1	0,0741	205,3	206,1	180,6	0,0097	180,6	180,7
			p2	205,8	0,1106	204,7	205,9	180,3	0,0123	180,3	180,3
			p3	206,4	0,1485	204,9	206,5	180,8	0,0187	180,7	180,8
			p4	206,2	0,1063	205,0	206,2	180,6	0,0165	180,5	180,6
12	200	200	p1	205,6	0,0154	205,5	205,6	181,2	0,0226	181,1	181,2
			p2	205,3	0,0231	205,2	205,4	181,2	0,0351	181,1	181,2
			p3	205,8	0,0310	205,7	205,9	182,0	0,0366	181,9	182,0
			p4	205,6	0,0241	205,5	205,6	181,5	0,0319	181,4	181,6
19	200	200	p1	205,9	0,0205	205,9	206,1	181,0	0,0048	180,9	181,0
			p2	205,7	0,0223	205,6	205,9	180,8	0,0071	180,8	180,8
			p3	206,2	0,0192	206,1	206,4	181,4	0,0100	181,3	181,4
			p4	205,9	0,0222	205,9	206,1	181,1	0,0083	181,0	181,1

Velocity excitation with static pressure 0 bar, see Table 13.

Table 13. Results overview of trial 2, velocity excitation with static pressure 0 bar.

Meas. id	Dist [m]	Nr of strokes	Sensor	Peak velocity [dB re 1 (nm/s) ²]				Integrated velocity [dB re 1 (nm/s) ² s]			
				mean	std	min	max	mean	std	min	max
7	100	100	v1	146,5	0,0249	146,4	146,6	122,4	0,0099	122,3	122,4
11	100	100	v1	146,2	0,0369	146,1	146,5	122,2	0,0260	122,1	122,4
14	100	100	v1	146,5	0,0288	146,5	146,7	122,4	0,0130	122,3	122,5
16	100	100	v1	146,8	0,0350	146,7	147,0	122,7	0,0119	122,7	122,8
6	200	200	v1	141,6	0,0659	141,0	141,8	117,6	0,0531	117,6	118,3
8	200	200	v1	141,7	0,0556	141,3	141,9	117,6	0,0329	117,6	118,0
15	200	200	v1	141,8	0,0778	141,3	142,2	117,7	0,0610	117,6	118,2
17	200	200	v1	141,6	0,0542	141,4	141,9	117,5	0,0224	117,5	117,7

3.4 Results of Trial 3

All the measurements of trial 3 are carried out at a static pressure of 0 bar.
Pressure excitation, see Table 14.

Table 14. Results overview of trial 3, pressure excitation (with static pressure 0 bar)

Meas. Id	Dist. [m]	Nr of strokes	Sensor	Peak pressure [dB re 1 μPa^2]				SEL [dB re 1 $\mu\text{Pa}^2\text{s}$]			
				mean	std	min	max	mean	std	min	max
1	100	1	1	209,6	-	-	-	185,8	-	-	-
			2	209,1	-	-	-	185,6	-	-	-
			3	209,3	-	-	-	186,2	-	-	-
			4	209,3	-	-	-	185,9	-	-	-
22	100	10	1	209,8	0,0097	209,8	209,8	185,9	0,0027	185,9	185,9
			2	209,4	0,1583	209,2	209,6	185,4	0,0098	185,4	185,4
			3	210,5	0,4791	209,5	211,0	185,8	0,0222	185,8	185,8
			4	209,5	0,0943	209,4	209,6	185,6	0,0109	185,6	185,6
23	100	10	1	209,8	0,0726	209,7	210,0	186,4	0,0580	186,3	186,5
			2	211,6	0,8240	209,7	212,3	186,6	0,0365	186,6	186,7
			3	213,1	0,7599	211,4	213,8	187,9	0,0404	187,8	187,9
			4	211,5	0,7210	210,2	212,2	187,0	0,0417	187,0	187,1
24	100	10	1	209,8	0,0208	209,8	209,9	185,8	0,0021	185,8	185,8
			2	209,3	0,0217	209,2	209,3	185,3	0,0021	185,2	185,3
			3	209,5	0,0231	209,5	209,5	185,6	0,0042	185,5	185,6
			4	209,5	0,0224	209,4	209,5	185,4	0,0020	185,4	185,5
25	100	10	1	210,0	0,0154	209,9	210,0	186,1	0,0131	186,0	186,1
			2	209,5	0,0167	209,4	209,5	185,6	0,0187	185,6	185,6
			3	209,7	0,0164	209,7	209,7	186,1	0,0180	186,0	186,1
			4	209,6	0,0130	209,6	209,7	185,8	0,0252	185,8	185,9
3	100	100	1	209,8	0,0535	209,7	210,0	185,8	0,0122	185,8	185,9
			2	209,2	0,0655	209,1	209,4	185,5	0,0083	185,5	185,6
			3	209,9	0,1223	209,6	210,1	186,0	0,0143	185,9	186,0
			4	209,5	0,0678	209,1	209,7	185,7	0,0166	185,7	185,9
9	100	100	1	210,3	0,0300	210,1	210,4	186,0	0,0090	186,0	186,0
			2	209,9	0,0316	209,7	210,0	185,7	0,0215	185,6	185,8
			3	210,2	0,0464	209,9	210,3	186,3	0,0349	186,1	186,3
			4	210,1	0,0322	209,9	210,2	185,9	0,0194	185,8	186,0
13	100	100	1	210,0	0,0536	209,9	210,1	185,7	0,0246	185,7	185,8
			2	209,7	0,0828	209,6	209,9	185,6	0,0230	185,5	185,6
			3	210,0	0,1064	209,8	210,3	186,0	0,0338	185,9	186,1
			4	209,9	0,0782	209,8	210,1	185,8	0,0256	185,7	185,9
15	100	100	1	209,9	0,0094	209,9	209,9	185,9	0,0056	185,9	185,9
			2	209,5	0,0155	209,4	209,5	185,4	0,0112	185,4	185,4
			3	209,8	0,0210	209,7	209,8	185,7	0,0135	185,7	185,8
			4	209,6	0,0136	209,6	209,7	185,6	0,0059	185,6	185,6
19	100	100	1	209,8	0,0127	209,7	209,8	185,7	0,0130	185,7	185,8
			2	209,3	0,0762	209,2	209,5	185,4	0,0105	185,3	185,4
			3	210,7	0,4789	209,5	211,2	185,8	0,0237	185,7	185,8
			4	209,6	0,1146	209,5	209,9	185,6	0,0089	185,6	185,7

Meas. Id	Dist. [m]	Nr of strokes	Sensor	Peak pressure [dB re 1 μPa^2]				SEL [dB re 1 $\mu\text{Pa}^2\text{s}$]			
				mean	std	min	max	mean	std	min	max
5	200	300	1	204,9	0,0519	204,6	205,2	180,9	0,0194	180,8	181,0
			2	204,4	0,0477	204,2	204,7	180,6	0,0283	180,5	180,7
			3	204,7	0,1459	204,4	205,0	181,1	0,0349	180,9	181,1
			4	204,7	0,0442	204,3	204,7	180,9	0,0312	180,7	181,0
7	200	300	1	205,0	0,0417	204,8	205,4	180,8	0,0558	180,7	181,0
			2	204,6	0,0312	204,6	204,8	180,6	0,0304	180,5	180,7
			3	204,9	0,0881	204,6	205,8	181,0	0,1381	180,9	182,3
			4	204,9	0,0315	204,8	205,0	180,9	0,0432	180,8	181,2
11	200	300	1	205,6	0,0434	205,2	205,6	181,1	0,0045	181,1	181,1
			2	205,2	0,0559	204,8	205,2	180,7	0,0049	180,7	180,7
			3	205,5	0,0729	205,0	205,6	181,1	0,0100	181,1	181,2
			4	205,3	0,0552	204,9	205,4	180,9	0,0048	180,9	180,9
16	200	300	1	205,3	0,0439	204,9	205,3	180,8	0,0489	180,7	180,8
			2	205,0	0,0581	204,6	205,1	180,4	0,0269	180,4	180,5
			3	205,4	0,0724	204,8	205,5	180,8	0,0317	180,7	180,8
			4	205,2	0,0579	204,8	205,3	180,7	0,0332	180,6	180,7
21	200	300	1	204,9	0,0389	204,9	205,3	181,1	0,0073	181,0	181,1
			2	204,4	0,0566	204,3	204,9	180,8	0,0101	180,8	180,8
			3	205,0	0,1584	204,5	205,2	181,3	0,0173	181,3	181,3
			4	204,6	0,0507	204,5	205,1	180,9	0,0113	180,9	181,0

Velocity excitation, see Table 15.

Table 15. Results overview of trial 3, velocity excitation (with static pressure 0 bar)

Meas. Id	Dist. [m]	Nr of strokes	Sensor	Peak velocity				Integrated velocity			
				[dB re 1 (nm/s) ²]				[dB re 1 (nm/s) ² s]			
				mean	std	min	max	mean	std	min	max
2	100	100	1	147,6	0,0465	147,3	147,7	124,7	0,0231	124,5	124,7
6	100	100	1	148,3	0,0295	148,2	148,4	125,0	0,0171	124,9	125,0
12	100	100	1	148,5	0,0424	148,4	148,6	125,3	0,0143	125,2	125,3
17	100	100	1	148,1	0,0422	147,9	148,2	125,0	0,0155	125,0	125,1
18	100	100	1	148,2	0,0366	148,1	148,4	125,1	0,0143	125,0	125,1
4*	200	300	1	148,3	0,0449	148,1	148,5	125,1	0,0168	125,0	125,2
8	200	300	1	143,5	0,0620	143,3	143,8	120,4	0,0309	120,3	120,7
10*	200	300	1	148,3	0,0426	148,2	148,6	125,2	0,0178	125,1	125,3
14	200	300	1	143,7	0,0559	143,5	144,2	120,4	0,0311	120,4	120,8
20	200	300	1	143,4	0,1249	143,2	143,7	120,4	0,0221	120,4	120,6

Notes:

- Measurement 4 and 10 (*) seem to contain measurements with an excitation signal of 100 meter instead of 200 meter.

Appendix F. TNO memo 6



TNO Science and Industry

Memorandum

From

P.W. Wessels

Subject

The effect of piling noise on the survival of fish larvae - experiments - memo-6: Trials 4 to 6 at Imares.

Date

31 March 2011

1 Introduction

This is the 6th memorandum of the experiments for determining the effect of underwater noise due to pile driving on the survival of fish larvae. Results of trial 4 to 6 will be shown; covering three consecutive larvae stages (1 to 3). Experiments were performed on the 24th of February, 2nd of March and on the 9th of March 2011. In total 30 measurements were performed on each of these three days, see table 1.

Table 1. Overview of the experiments with real larvae.

Trial Nr.	Date of measurements	Measurement nr.	Excitation type	Larvae container no.	Simulated distance	Number of strokes
4	24 February 2011	1-15	pressure	1-15 : 100	100	100
		1-15	pressure	1-15 : 200	200	100
5	2 March 2011	1-15	pressure	1-15 : 100	100	100
		1-15	pressure	1-15 : 200	200	100
6	9 March 2011	1-15	pressure	1-15 : 100	100	100
		1-15	pressure	1-15 : 200	200	100

As can be seen in table 1, each measurement day had the same setup. Containers with 25 larvae (batch) were exposed to a pressure excitation, of 100 strokes, at a simulated distance of either 100 or 200 meters.

2 General aspects of the measurements

The acoustic results of the trials are shown in Table 3 to Table 8. Except one, all measurements of trial 4 to 6 are considered to be valid. One measurement: trial 4, measurement 13, distance 100 m is invalid; due to a loss of measurement data (this doesn't mean the measurement itself is invalid. After all, there is no reason to doubt that the excitation setup didn't function correctly and the pressure is incorrect. However, this cannot be checked anymore).

The data in Table 3 to Table 8 are the result of a statistical analysis of series of measurements. Every measurement series consists of 100 separate strokes, in which there was some variation. The following values are shown: the mean value, standard deviation, minimum and the maximum of the peak pressure and SEL, per measurement (100 strokes). This analysis is done for the four pressure sensors. These four sensors should display almost identical values, because an uniform pressure is assumed.

During some measurements a small air bubble caused the peak pressure and the SEL to vary, which results in a higher standard deviation. However the peak and SEL levels stay within an acceptable range. Notes have been placed below the tables to further explain certain results.

Total values for integrated velocity and SEL

The values for integrated velocity and SEL considering the total number of strokes in one measurement, can be obtained by adding $10 \cdot 10 \log(N)$ to the mean values. Where N is the number of strokes per measurement. The resulting additions are given in Table 2.

Table 2. Additions to SEL and the integrated velocity

Number of strokes	Addition to the mean SEL value	Addition to the mean integrated velocity value
	dB re 1 μ Pa ² s	dB re 1 (nm/s) ² s
1		0
10		10.0
50		17.0
70		18.5
100		20.0
200		23.0
300		24.8

3 Acoustic results Trials 4 to 6

3.1 Trial 4, larvae stage 1

Pressure excitation, distance 100 meter,
 Target: peak pressure 210 dB re 1 μPa^2 , SEL 188 dB re 1 $\mu\text{Pa}^2\text{s}$

Table 3. Results overview of trial 4, distance 100meter.

Meas. id	Dist. [m]	Sensor	Peak pressure [dB re 1 μPa^2]				SEL [dB re 1 $\mu\text{Pa}^2\text{s}$]			
			Mean	Std	Min	Max	Mean	Std	Min	Max
1	100	1	209,5	0,0345	209,4	209,6	185,5	0,0050	185,5	185,5
		2	208,9	0,0444	208,8	209,1	185,0	0,0043	185,0	185,0
		3	209,3	0,0523	209,2	209,5	185,4	0,0096	185,4	185,4
		4	209,2	0,0412	209,1	209,4	185,3	0,0044	185,3	185,3
2	100	1	208,9	0,0092	208,9	208,9	185,2	0,0091	185,2	185,2
		2	208,3	0,0120	208,3	208,4	184,9	0,0183	184,9	185,0
		3	208,8	0,1303	208,6	209,0	185,5	0,0274	185,4	185,5
		4	208,7	0,0134	208,7	208,7	185,3	0,0162	185,2	185,3
3	100	1	209,1	0,0340	209,1	209,3	185,3	0,0099	185,3	185,4
		2	208,5	0,0388	208,5	208,8	185,0	0,0173	185,0	185,0
		3	209,9	0,4143	208,9	210,4	185,5	0,0378	185,4	185,6
		4	208,9	0,0422	208,8	209,1	185,3	0,0208	185,3	185,4
4	100	1	209,4	0,0056	209,3	209,4	185,7	0,0293	185,6	185,7
		2	208,9	0,0110	208,9	208,9	185,3	0,0268	185,2	185,3
		3	209,3	0,0123	209,3	209,3	185,9	0,0318	185,7	185,9
		4	209,2	0,0051	209,2	209,2	185,7	0,0299	185,6	185,7
5	100	1	210,3	0,0229	210,2	210,3	186,1	0,0139	186,0	186,1
		2	210,1	0,0267	209,9	210,1	186,1	0,0188	186,0	186,1
		3	210,7	0,0382	210,5	210,8	187,0	0,0479	186,9	187,1
		4	210,4	0,0268	210,3	210,5	186,5	0,0236	186,4	186,5
6	100	1	210,1	0,0209	209,9	210,1	185,9	0,0130	185,9	185,9
		2	209,8	0,0270	209,6	209,8	185,8	0,0133	185,8	185,8
		3	210,3	0,0354	210,0	210,3	186,6	0,0188	186,5	186,6
		4	210,1	0,0284	209,9	210,1	186,2	0,0146	186,2	186,2
7	100	1	209,7	0,2908	208,6	209,8	185,5	0,5590	182,9	185,8
		2	209,1	0,2901	208,1	209,3	184,9	0,5589	182,3	185,2
		3	209,6	0,2903	208,5	209,7	185,4	0,5606	182,8	185,7
		4	209,5	0,2900	208,4	209,6	185,3	0,5600	182,7	185,5
8	100	1	210,1	0,0375	209,9	210,1	186,1	0,0179	186,0	186,1
		2	209,6	0,0449	209,4	209,6	185,6	0,0233	185,5	185,6
		3	210,1	0,0503	209,8	210,1	186,2	0,0318	186,1	186,2
		4	209,9	0,0419	209,7	209,9	185,9	0,0278	185,9	186,0
9	100	1	209,7	0,0211	209,7	209,8	185,7	0,0103	185,7	185,8
		2	211,0	0,2555	209,1	211,2	185,3	0,0024	185,3	185,3
		3	212,4	0,2800	210,4	212,6	185,9	0,0046	185,9	185,9
		4	210,8	0,1865	209,4	210,9	185,6	0,0034	185,6	185,6

Meas. id	Dist. [m]	Sensor	Peak pressure [dB re 1 μPa^2]				SEL [dB re 1 $\mu\text{Pa}^2\text{s}$]			
			Mean	Std	Min	Max	Mean	Std	Min	Max
10	100	1	209,9	0,0116	209,8	209,9	185,7	0,0066	185,7	185,7
		2	209,3	0,0145	209,2	209,3	185,1	0,0070	185,0	185,1
		3	209,7	0,0187	209,7	209,8	185,5	0,0098	185,4	185,5
		4	209,6	0,0150	209,6	209,7	185,4	0,0076	185,4	185,4
11	100	1	209,8	0,0134	209,8	209,9	185,8	0,0032	185,8	185,8
		2	209,3	0,0092	209,2	209,3	185,2	0,0037	185,2	185,2
		3	209,7	0,0134	209,7	209,7	185,7	0,0071	185,6	185,7
		4	209,6	0,0116	209,6	209,6	185,6	0,0046	185,5	185,6
12	100	1	209,8	0,0167	209,8	209,9	185,7	0,0039	185,7	185,7
		2	209,2	0,0182	209,1	209,2	185,1	0,0035	185,0	185,1
		3	209,6	0,0168	209,5	209,6	185,5	0,0057	185,4	185,5
		4	209,5	0,0177	209,5	209,6	185,4	0,0041	185,4	185,4
13	100	1	-	-	-	-	-	-	-	-
		2	-	-	-	-	-	-	-	-
		3	-	-	-	-	-	-	-	-
		4	-	-	-	-	-	-	-	-
14	100	1	209,7	0,0156	209,6	209,7	185,6	0,0058	185,6	185,6
		2	209,1	0,0079	209,1	209,1	184,9	0,0119	184,9	184,9
		3	209,5	0,0060	209,5	209,5	185,3	0,0147	185,3	185,4
		4	209,5	0,0075	209,4	209,5	185,3	0,0117	185,3	185,3
15	100	1	209,7	0,0150	209,7	209,7	185,7	0,0084	185,7	185,7
		2	209,1	0,0109	209,1	209,1	185,1	0,0192	185,0	185,1
		3	209,5	0,0143	209,5	209,6	185,6	0,0255	185,5	185,6
		4	209,5	0,0103	209,4	209,5	185,4	0,0196	185,4	185,5

Notes:

- Measurement 13: no data available, due to data loss.
- Measurements 7, 9: a small bubble of air caused small fluctuations in the pressure.
- The highest mean peak pressure value is found in measurement 9, sensor 3: peak pressure 212,4dB

3.2 Trial 4, larvae stage 1

Pressure excitation, distance 200 meter,

Target: peak pressure 205 dB re 1 μPa^2 , SEL 183 dB re 1 $\mu\text{Pa}^2\text{s}$

Table 4. Results overview of trial 4, distance 200 meter.

Meas. id	Dist. [m]	Sensor	Peak pressure [dB re 1 μPa^2]				SEL [dB re 1 $\mu\text{Pa}^2\text{s}$]			
			Mean	Std	Min	Max	Mean	Std	Min	Max
1	200	1	205,3	0,0065	205,3	205,3	180,9	0,0027	180,8	180,9
		2	204,9	0,0131	204,9	204,9	180,4	0,0045	180,4	180,4
		3	205,4	0,0179	205,4	205,4	180,9	0,0061	180,9	180,9
		4	205,1	0,0125	205,1	205,2	180,7	0,0042	180,7	180,7
2	200	1	204,6	0,0148	204,6	204,6	180,6	0,0016	180,6	180,6
		2	204,1	0,0181	204,1	204,2	180,2	0,0035	180,2	180,2
		3	204,4	0,0212	204,4	204,5	180,7	0,0076	180,6	180,7
		4	204,4	0,0181	204,4	204,4	180,5	0,0045	180,5	180,5
3	200	1	206,2	0,0217	206,1	206,3	181,8	0,0033	181,8	181,8
		2	205,7	0,0247	205,6	205,8	181,5	0,0047	181,5	181,5
		3	206,1	0,0251	206,0	206,2	181,9	0,0090	181,9	181,9
		4	206,0	0,0235	205,9	206,1	181,8	0,0046	181,7	181,8
4	200	1	204,7	0,0040	204,7	204,7	180,6	0,0025	180,6	180,6
		2	204,2	0,0053	204,2	204,2	180,1	0,0042	180,1	180,1
		3	204,6	0,0018	204,6	204,7	180,5	0,0047	180,5	180,6
		4	204,6	0,0026	204,6	204,6	180,5	0,0040	180,5	180,5
5	200	1	204,7	0,0064	204,7	204,7	180,7	0,0057	180,7	180,7
		2	204,2	0,0100	204,2	204,2	180,3	0,0099	180,2	180,3
		3	204,6	0,0080	204,6	204,6	180,7	0,0118	180,7	180,7
		4	204,5	0,0088	204,5	204,6	180,6	0,0094	180,6	180,6
6	200	1	205,2	0,0506	205,0	205,3	180,9	0,0284	180,8	181,0
		2	204,8	0,0606	204,6	204,9	180,4	0,0366	180,3	180,5
		3	205,3	0,0625	205,1	205,4	181,0	0,0403	180,8	181,0
		4	205,1	0,0573	204,9	205,2	180,7	0,0347	180,6	180,8
7	200	1	204,8	0,0267	204,8	204,9	180,9	0,0019	180,9	180,9
		2	204,3	0,1194	204,2	204,6	180,3	0,0126	180,3	180,3
		3	205,9	0,4825	204,7	206,5	180,9	0,0288	180,8	180,9
		4	204,6	0,1067	204,5	204,9	180,6	0,0118	180,6	180,7
8	200	1	205,1	0,0456	205,0	205,2	181,0	0,0542	180,9	181,1
		2	204,5	0,0461	204,4	204,6	180,5	0,0535	180,3	180,5
		3	205,0	0,0473	204,8	205,0	181,0	0,0506	180,8	181,0
		4	204,9	0,0454	204,7	204,9	180,8	0,0527	180,7	180,9
9	200	1	205,8	0,1109	205,6	205,9	181,3	0,0372	181,3	181,4
		2	205,5	0,0891	205,4	205,7	181,0	0,0323	181,0	181,1
		3	206,3	0,0880	206,0	206,4	181,8	0,0324	181,8	181,9
		4	205,9	0,0852	205,7	206,0	181,4	0,0327	181,4	181,5
10	200	1	205,3	0,0216	205,2	205,4	180,9	0,0035	180,9	181,0
		2	204,8	0,0350	204,7	204,9	180,4	0,0026	180,4	180,4
		3	205,2	0,0417	205,0	205,3	180,9	0,0042	180,9	180,9
		4	205,1	0,0301	205,0	205,2	180,7	0,0019	180,7	180,7

Meas. id	Dist. [m]	Sensor	Peak pressure [dB re 1 μPa^2]				SEL [dB re 1 $\mu\text{Pa}^2\text{s}$]			
			Mean	Std	Min	Max	Mean	Std	Min	Max
11	200	1	204,9	0,0063	204,9	205,0	180,8	0,0023	180,8	180,8
		2	204,3	0,0088	204,3	204,4	180,1	0,0048	180,1	180,1
		3	204,7	0,0092	204,7	204,8	180,5	0,0057	180,5	180,5
		4	204,7	0,0082	204,7	204,7	180,5	0,0041	180,4	180,5
12	200	1	205,0	0,0074	205,0	205,0	180,8	0,0024	180,8	180,8
		2	204,4	0,0062	204,4	204,4	180,1	0,0062	180,1	180,1
		3	204,8	0,0031	204,8	204,8	180,5	0,0075	180,5	180,5
		4	204,7	0,0038	204,7	204,7	180,5	0,0052	180,4	180,5
13	200	1	205,1	0,0535	205,0	205,2	180,9	0,0034	180,9	180,9
		2	204,5	0,0703	204,4	204,6	180,2	0,0070	180,2	180,3
		3	204,9	0,0742	204,8	205,0	180,7	0,0105	180,7	180,7
		4	204,9	0,0632	204,8	204,9	180,6	0,0056	180,5	180,6
14	200	1	204,9	0,0157	204,8	204,9	180,8	0,0081	180,8	180,8
		2	204,3	0,0098	204,2	204,3	180,1	0,0029	180,1	180,1
		3	204,6	0,0076	204,6	204,6	180,5	0,0041	180,5	180,5
		4	204,6	0,0085	204,6	204,6	180,4	0,0027	180,4	180,5
15	200	1	205,0	0,0143	204,9	205,0	180,8	0,0057	180,8	180,8
		2	204,4	0,0103	204,4	204,4	180,1	0,0035	180,1	180,1
		3	204,8	0,0085	204,8	204,9	180,5	0,0045	180,5	180,5
		4	204,8	0,0087	204,7	204,8	180,4	0,0035	180,4	180,5

Notes:

- None

3.3. Trial 5, larvae stage 2

Pressure excitation, distance 100 meter,

Target: peak pressure 210 dB re 1 μPa^2 , SEL 188 dB re 1 $\mu\text{Pa}^2\text{s}$

Table 5. Results overview of trial 5, distance 100meter.

Meas. id	Dist. [m]	Sensor	Peak pressure [dB re 1 μPa^2]				SEL [dB re 1 $\mu\text{Pa}^2\text{s}$]			
			Mean	Std	Min	Max	Mean	Std	Min	Max
1	100	1	-	-	-	-	-	-	-	-
		2	209,3	0,0110	209,2	209,3	185,5	0,0081	185,5	185,5
		3	209,4	0,0120	209,4	209,4	185,5	0,0053	185,5	185,5
		4	-	-	-	-	-	-	-	-
2	100	1	-	-	-	-	-	-	-	-
		2	209,2	0,0090	209,2	209,3	185,6	0,0126	185,6	185,6
		3	209,4	0,0096	209,3	209,4	185,6	0,0101	185,6	185,6
		4	-	-	-	-	-	-	-	-
3	100	1	-	-	-	-	-	-	-	-
		2	209,2	0,0202	209,2	209,3	185,3	0,0099	185,3	185,3
		3	209,3	0,0170	209,3	209,4	185,4	0,0084	185,4	185,4
		4	-	-	-	-	-	-	-	-
4	100	1	-	-	-	-	-	-	-	-
		2	209,3	0,1043	209,2	209,5	185,2	0,0079	185,2	185,2
		3	209,4	0,0892	209,4	209,6	185,3	0,0053	185,3	185,3
		4	-	-	-	-	-	-	-	-
5	100	1	-	-	-	-	-	-	-	-
		2	209,9	0,3766	209,0	210,3	185,8	0,7035	184,1	186,3
		3	209,9	0,3827	208,9	210,2	185,6	0,6999	183,9	186,1
		4	-	-	-	-	-	-	-	-
6	100	1	-	-	-	-	-	-	-	-
		2	209,4	0,0230	209,3	209,5	185,4	0,0077	185,4	185,4
		3	209,5	0,0146	209,4	209,5	185,4	0,0070	185,4	185,4
		4	-	-	-	-	-	-	-	-
7	100	1	-	-	-	-	-	-	-	-
		2	209,0	0,3950	208,2	209,3	184,7	0,7599	182,9	185,2
		3	209,1	0,4058	208,3	209,4	184,8	0,7568	183,0	185,3
		4	-	-	-	-	-	-	-	-
8	100	1	209,7	0,0140	209,7	209,8	185,6	0,0060	185,6	185,7
		2	209,3	0,0217	209,2	209,3	185,1	0,0062	185,1	185,1
		3	209,6	0,0278	209,5	209,7	185,6	0,0074	185,5	185,6
		4	209,5	0,0191	209,4	209,5	185,4	0,0059	185,4	185,4
9	100	1	209,9	0,0113	209,8	209,9	185,9	0,0171	185,8	185,9
		2	209,4	0,0109	209,3	209,4	185,5	0,0199	185,4	185,5
		3	209,8	0,0120	209,7	209,9	186,1	0,0254	185,9	186,1
		4	209,7	0,0089	209,6	209,7	185,8	0,0212	185,7	185,8
10	100	1	207,8	0,2659	207,5	209,1	181,7	0,2278	181,3	182,7
		2	207,4	0,2660	207,1	208,7	181,2	0,2279	180,8	182,2
		3	207,8	0,2694	207,6	209,2	181,6	0,2289	181,2	182,6
		4	207,7	0,2670	207,4	209,0	181,5	0,2287	181,1	182,5

Meas. id	Dist. [m]	Sensor	Peak pressure [dB re 1 μPa^2]				SEL [dB re 1 $\mu\text{Pa}^2\text{s}$]			
			Mean	Std	Min	Max	Mean	Std	Min	Max
11	100	1	207,7	0,1337	207,5	208,1	181,3	0,2559	181,0	182,1
		2	207,2	0,1336	207,0	207,6	180,8	0,2546	180,4	181,6
		3	207,7	0,1333	207,5	208,1	181,1	0,2556	180,8	182,0
		4	207,5	0,1329	207,3	207,9	181,1	0,2552	180,7	181,9
12	100	1	209,6	0,0276	209,5	209,6	185,6	0,0071	185,5	185,6
		2	209,1	0,0673	209,0	209,2	185,1	0,0115	185,1	185,1
		3	209,4	0,1013	209,3	209,6	185,5	0,0154	185,5	185,5
		4	209,4	0,0647	209,3	209,5	185,4	0,0112	185,4	185,4
13	100	1	210,1	0,0529	209,9	210,2	185,9	0,0115	185,8	185,9
		2	209,8	0,0800	209,5	209,9	185,6	0,0134	185,5	185,6
		3	210,3	0,1023	209,9	210,4	186,2	0,0176	186,2	186,2
		4	210,0	0,0767	209,8	210,1	185,9	0,0143	185,9	185,9
14	100	1	209,5	0,0142	209,5	209,5	185,5	0,0316	185,4	185,5
		2	209,1	0,0177	209,1	209,1	185,1	0,0136	185,1	185,2
		3	209,5	0,0174	209,4	209,5	185,5	0,0151	185,5	185,6
		4	209,3	0,0142	209,3	209,4	185,4	0,0203	185,4	185,5
15	100	1	210,1	0,0200	210,1	210,2	186,0	0,0241	186,0	186,1
		2	-	-	-	-	-	-	-	-
		3	210,7	0,0247	210,5	210,7	187,1	0,0251	187,0	187,1
		4	210,2	0,0202	210,1	210,3	186,3	0,0247	186,3	186,4

Notes:

- Values of sensor 1 and 4 are not shown for measurements 1 to 7, due to sensor connection problems.
- Measurements 5, 7: a small bubble of air caused small fluctuations in the pressure.
- Measurements 10 and 11 show lower values than expected. Cause unknown.
- Measurement 15, sensor 2 shows unrealistic values. This due to a measurement error. The excitation is expected to be correct.

3.4 Trial 5, larvae stage 2

Pressure excitation, distance 200 meter,

Target: peak pressure 205 dB re 1 μPa^2 , SEL 183 dB re 1 $\mu\text{Pa}^2\text{s}$

Table 6. Results overview of trial 5, distance 200 meter.

Meas. id	Dist. [m]	Sensor	Peak pressure [dB re 1 μPa^2]				SEL [dB re 1 $\mu\text{Pa}^2\text{s}$]			
			Mean	Std	Min	Max	Mean	Std	Min	Max
1	200	1	-	-	-	-	-	-	-	-
		2	204,5	0,0172	204,5	204,6	180,5	0,0016	180,5	180,5
		3	204,7	0,0131	204,7	204,7	180,6	0,0025	180,6	180,6
		4	-	-	-	-	-	-	-	-
2	200	1	-	-	-	-	-	-	-	-
		2	204,6	0,0206	204,5	204,7	180,9	0,0104	180,8	180,9
		3	204,8	0,0299	204,7	204,9	180,9	0,0057	180,8	180,9
		4	-	-	-	-	-	-	-	-
3	200	1	-	-	-	-	-	-	-	-
		2	204,7	0,0089	204,6	204,7	180,3	0,0049	180,3	180,3
		3	204,7	0,0121	204,7	204,8	180,4	0,0059	180,4	180,5
		4	-	-	-	-	-	-	-	-
4	200	1	-	-	-	-	-	-	-	-
		2	204,7	0,0270	204,6	204,8	180,5	0,0146	180,5	180,5
		3	204,7	0,0228	204,7	204,8	180,6	0,0151	180,5	180,6
		4	-	-	-	-	-	-	-	-
5	200	1	-	-	-	-	-	-	-	-
		2	205,8	0,0702	205,8	206,2	182,0	0,0093	182,0	182,1
		3	205,5	0,0542	205,5	205,9	181,6	0,0083	181,6	181,6
		4	-	-	-	-	-	-	-	-
6	200	1	-	-	-	-	-	-	-	-
		2	204,0	1,0343	202,8	205,6	178,5	1,8740	176,4	180,9
		3	203,9	1,0804	202,7	205,4	178,4	1,8834	176,3	180,8
		4	-	-	-	-	-	-	-	-
7	200	1	-	-	-	-	-	-	-	-
		2	205,2	0,0813	204,9	205,3	181,0	0,0830	180,7	181,1
		3	205,2	0,0812	204,9	205,3	180,9	0,0789	180,6	181,0
		4	-	-	-	-	-	-	-	-
8	200	1	205,5	0,1422	205,3	205,7	181,0	0,0566	181,0	181,2
		2	205,4	0,1368	205,1	205,6	180,7	0,0522	180,6	180,8
		3	205,9	0,1313	205,6	206,2	181,3	0,0456	181,2	181,4
		4	205,6	0,1185	205,4	205,8	181,0	0,0436	180,9	181,1
9	200	1	205,5	0,0145	205,5	205,6	180,8	0,0275	180,8	180,9
		2	205,4	0,0383	205,2	205,4	180,6	0,0265	180,6	180,7
		3	206,0	0,0610	205,6	206,0	181,2	0,0255	181,2	181,3
		4	205,6	0,0407	205,4	205,7	180,9	0,0253	180,9	181,0
10	200	1	202,0	0,0854	201,8	202,2	175,4	0,1099	175,2	175,7
		2	201,6	0,0816	201,4	201,8	175,0	0,1090	174,8	175,3
		3	202,1	0,0751	201,9	202,3	175,5	0,1095	175,3	175,8
		4	201,9	0,0792	201,8	202,1	175,3	0,1105	175,1	175,6

Meas. id	Dist. [m]	Sensor	Peak pressure [dB re 1 μPa^2]				SEL [dB re 1 $\mu\text{Pa}^2\text{s}$]			
			Mean	Std	Min	Max	Mean	Std	Min	Max
11	200	1	205,5	0,0341	205,3	205,5	180,8	0,0992	180,0	180,9
		2	205,3	0,0459	204,9	205,3	180,4	0,0971	179,6	180,4
		3	205,8	0,0605	205,3	205,8	180,9	0,0926	180,2	181,0
		4	205,5	0,0439	205,1	205,5	180,7	0,0959	179,9	180,7
12	200	1	205,6	0,0849	205,2	205,6	180,9	0,0272	180,9	181,0
		2	205,2	0,1255	204,7	205,3	180,5	0,0279	180,5	180,6
		3	205,7	0,1626	205,1	205,8	181,1	0,0305	181,0	181,1
		4	205,5	0,1282	205,0	205,5	180,9	0,0296	180,8	180,9
13	200	1	205,0	0,0389	204,8	205,1	180,8	0,0376	180,7	180,8
		2	204,5	0,0516	204,3	204,6	180,2	0,0371	180,2	180,3
		3	204,9	0,0620	204,6	204,9	180,6	0,0353	180,6	180,7
		4	204,7	0,0481	204,6	204,8	180,5	0,0360	180,5	180,6
14	200	1	205,2	0,1264	205,0	205,7	180,8	0,0770	180,7	180,9
		2	205,0	0,1262	204,7	205,5	180,4	0,0902	180,4	180,6
		3	205,5	0,1626	205,1	206,1	180,9	0,0987	180,9	181,2
		4	205,2	0,1269	204,9	205,7	180,7	0,0982	180,6	180,9
15	200	1	205,9	0,0338	205,7	205,9	181,2	0,0291	181,2	181,2
		2	-	-	-	-	-	-	-	-
		3	206,3	0,0557	206,0	206,4	181,8	0,0361	181,8	181,9
		4	206,0	0,0489	205,6	206,0	181,4	0,0276	181,3	181,4

Notes:

- Values of sensor 1 and 4 are not shown for measurements 1 to 7, due to sensor connection problems.
- Measurement 6: a small bubble of air caused small fluctuations in the pressure.
- Measurement 10 shows lower values than expected. Cause unknown.
- Measurement 15, sensor 2 shows unrealistic values. This due to a measurement error.

3.5 Trial 6, larvae stage 3

Pressure excitation, distance 100 meter,
 Target: peak pressure 210 dB re 1 μPa^2 , SEL 188 dB re 1 $\mu\text{Pa}^2\text{s}$

Table 7. Results overview of trial 6, distance 100 meter.

Meas. id	Dist. [m]	Sensor	Peak pressure [dB re 1 μPa^2]				SEL [dB re 1 $\mu\text{Pa}^2\text{s}$]			
			Mean	Std	Min	Max	Mean	Std	Min	Max
1	100	1	209,4	0,0047	209,4	209,4	185,5	0,0123	185,5	185,6
		2	209,0	0,0087	209,0	209,0	185,3	0,0175	185,3	185,4
		3	209,2	0,0099	209,2	209,2	185,7	0,0177	185,7	185,8
		4	209,2	0,0127	209,1	209,2	185,5	0,0145	185,5	185,5
2	100	1	210,0	0,0304	209,7	210,0	185,8	0,0122	185,7	185,8
		2	209,7	0,0401	209,3	209,7	185,7	0,0155	185,7	185,7
		3	210,0	0,0520	209,5	210,0	186,3	0,0185	186,2	186,3
		4	209,8	0,0401	209,5	209,9	185,9	0,0140	185,9	186,0
3	100	1	209,1	0,6126	208,1	209,8	184,4	1,2922	182,2	185,7
		2	208,8	0,6102	207,8	209,5	184,4	1,2936	182,2	185,7
		3	209,1	0,6010	208,1	209,9	184,9	1,2974	182,7	186,2
		4	209,0	0,6097	208,0	209,7	184,6	1,2979	182,4	186,0
4	100	1	209,8	0,1957	208,9	209,9	185,5	0,3704	183,6	185,6
		2	209,6	0,2170	208,6	210,3	185,4	0,3772	183,5	185,6
		3	210,1	0,5873	208,9	212,2	186,0	0,3849	184,0	186,2
		4	209,9	0,3538	208,7	211,2	185,7	0,3771	183,8	185,9
5	100	1	209,5	0,0462	209,4	209,7	185,4	0,0172	185,4	185,4
		2	209,1	0,0507	208,9	209,2	185,2	0,0244	185,1	185,2
		3	209,3	0,0513	209,1	209,4	185,6	0,0297	185,5	185,6
		4	209,3	0,0480	209,2	209,5	185,4	0,0232	185,4	185,5
6	100	1	209,2	0,3594	208,3	209,5	185,0	0,9939	182,2	185,5
		2	208,8	0,3055	208,0	209,0	184,7	1,0066	181,9	185,3
		3	209,1	0,2503	208,5	209,3	185,2	1,0193	182,3	185,7
		4	209,1	0,3026	208,3	209,3	185,0	1,0062	182,2	185,5
7	100	1	209,8	0,0340	209,6	209,9	185,6	0,0121	185,5	185,6
		2	209,6	0,0487	209,2	209,6	185,5	0,0240	185,4	185,5
		3	209,9	0,0517	209,5	209,9	186,0	0,0286	185,9	186,0
		4	209,7	0,0446	209,4	209,8	185,7	0,0186	185,7	185,7
8	100	1	209,7	0,0194	209,6	209,8	185,7	0,0112	185,7	185,7
		2	209,4	0,0273	209,2	209,5	185,6	0,0143	185,5	185,6
		3	209,6	0,0307	209,5	209,8	186,1	0,0162	186,0	186,1
		4	209,6	0,0291	209,4	209,7	185,8	0,0139	185,8	185,9
9	100	1	209,6	0,0042	209,6	209,6	185,6	0,0105	185,5	185,6
		2	209,2	0,0062	209,2	209,2	185,2	0,0159	185,2	185,3
		3	209,6	0,0055	209,5	209,6	185,6	0,0165	185,5	185,6
		4	209,5	0,0095	209,5	209,5	185,5	0,0132	185,4	185,5
10	100	1	209,6	0,0244	209,4	209,7	185,6	0,0089	185,5	185,6
		2	209,2	0,0295	209,0	209,3	185,3	0,0118	185,3	185,3
		3	209,4	0,0300	209,2	209,5	185,7	0,0128	185,7	185,7
		4	209,4	0,0272	209,2	209,4	185,6	0,0103	185,5	185,6

Meas. id	Dist. [m]	Sensor	Peak pressure [dB re 1 μPa^2]				SEL [dB re 1 $\mu\text{Pa}^2\text{s}$]			
			Mean	Std	Min	Max	Mean	Std	Min	Max
11	100	1	209,8	0,0225	209,8	210,0	185,5	0,0272	185,4	185,5
		2	209,6	0,0302	209,5	209,8	185,4	0,0396	185,3	185,4
		3	209,9	0,0564	209,8	210,2	186,0	0,0518	185,8	186,0
		4	209,7	0,0336	209,7	210,0	185,6	0,0383	185,5	185,7
12	100	1	209,6	0,0320	209,5	209,7	185,5	0,0175	185,5	185,6
		2	209,1	0,0313	209,1	209,3	185,3	0,0251	185,2	185,3
		3	209,4	0,0343	209,2	209,4	185,7	0,0303	185,6	185,8
		4	209,4	0,0322	209,3	209,5	185,5	0,0237	185,4	185,5
13	100	1	209,5	0,0207	209,4	209,5	185,5	0,0086	185,5	185,5
		2	209,0	0,0254	208,9	209,1	185,3	0,0116	185,3	185,3
		3	209,3	0,0252	209,1	209,3	185,8	0,0125	185,8	185,8
		4	209,3	0,0251	209,1	209,3	185,6	0,0103	185,5	185,6
14	100	1	209,5	0,0072	209,4	209,5	185,6	0,0063	185,6	185,6
		2	209,0	0,0100	209,0	209,0	185,3	0,0096	185,3	185,3
		3	209,3	0,0124	209,2	209,3	185,7	0,0098	185,7	185,7
		4	209,3	0,0137	209,2	209,3	185,6	0,0074	185,5	185,6
15	100	1	209,5	0,1201	209,4	210,0	185,6	0,0456	185,5	185,6
		2	209,1	0,1657	209,0	209,8	185,4	0,0675	185,2	185,4
		3	209,4	0,2240	209,2	210,3	185,9	0,0926	185,6	186,0
		4	209,3	0,1589	209,2	210,0	185,6	0,0636	185,4	185,7

Notes:

- Measurements 3, 4, 6: a small bubble of air caused small fluctuations in the pressure.

3.6 Trial 6, larvae stage 3

Pressure excitation, distance 200 meter,

Target: peak pressure 205 dB re 1 μPa^2 , SEL 183 dB re 1 $\mu\text{Pa}^2\text{s}$

Table 8. Results overview of trial 6, distance 200 meter.

Meas. id	Dist. [m]	Sensor	Peak pressure [dB re 1 μPa^2]				SEL [dB re 1 $\mu\text{Pa}^2\text{s}$]			
			Mean	Std	Min	Max	Mean	Std	Min	Max
1	200	1	205,6	0,0125	205,5	205,6	180,7	0,0035	180,7	180,7
		2	205,4	0,0229	205,3	205,5	180,6	0,0042	180,6	180,6
		3	205,9	0,0347	205,7	206,0	181,1	0,0057	181,1	181,1
		4	205,6	0,0256	205,4	205,7	180,8	0,0045	180,8	180,8
2	200	1	205,1	0,6514	203,4	205,8	180,5	0,8525	178,1	181,1
		2	205,1	0,6689	203,3	205,8	180,6	0,8564	178,1	181,1
		3	205,8	0,6709	204,0	206,4	181,4	0,8591	178,9	181,9
		4	205,3	0,6586	203,6	206,0	180,9	0,8575	178,4	181,4
3	200	1	204,9	1,1065	202,9	205,7	179,8	1,7409	176,6	180,9
		2	204,9	1,1344	202,7	205,7	179,8	1,7245	176,6	181,0
		3	205,5	1,1408	203,3	206,2	180,6	1,7001	177,4	181,7
		4	205,1	1,1263	203,0	205,9	180,1	1,7241	176,9	181,3
4	200	1	205,8	0,0347	205,7	205,8	181,0	0,0066	181,0	181,0
		2	205,6	0,0401	205,5	205,7	180,9	0,0096	180,9	180,9
		3	206,1	0,0435	205,9	206,2	181,5	0,0128	181,5	181,5
		4	205,9	0,0423	205,7	205,9	181,2	0,0106	181,2	181,2
5	200	1	204,7	0,6190	203,6	205,5	180,1	0,5844	178,4	180,7
		2	204,5	0,6681	203,2	205,3	179,8	0,5853	178,1	180,5
		3	204,8	0,7255	203,4	205,7	180,3	0,5869	178,5	180,9
		4	204,7	0,6742	203,4	205,6	180,1	0,5858	178,4	180,7
6	200	1	205,6	0,2479	204,8	205,8	180,9	0,2716	180,0	181,1
		2	205,5	0,2468	204,8	205,8	181,0	0,2701	180,1	181,2
		3	206,1	0,2442	205,4	206,4	181,7	0,2684	180,9	181,9
		4	205,8	0,2440	205,0	206,0	181,3	0,2701	180,4	181,5
7	200	1	205,4	0,0376	205,1	205,5	180,9	0,0136	180,8	180,9
		2	205,1	0,0526	204,7	205,2	180,7	0,0169	180,7	180,7
		3	205,5	0,0722	205,0	205,7	181,3	0,0169	181,3	181,3
		4	205,4	0,0564	205,0	205,5	181,0	0,0209	180,9	181,0
8	200	1	205,1	0,0734	204,8	205,1	180,7	0,0119	180,7	180,8
		2	204,7	0,0781	204,4	204,7	180,5	0,0131	180,5	180,5
		3	205,0	0,0909	204,6	205,1	181,0	0,0139	181,0	181,0
		4	204,9	0,0778	204,6	205,0	180,7	0,0130	180,7	180,8
9	200	1	205,4	0,0672	205,2	205,6	180,8	0,0280	180,8	180,9
		2	205,2	0,0751	205,1	205,4	180,6	0,0405	180,5	180,7
		3	205,7	0,0755	205,5	205,9	181,0	0,0463	181,0	181,2
		4	205,4	0,0782	205,2	205,6	180,8	0,0392	180,8	181,0
10	200	1	205,5	0,1388	204,8	205,5	180,7	0,0125	180,7	180,8
		2	205,2	0,1827	204,3	205,3	180,5	0,0112	180,5	180,6
		3	205,6	0,2397	204,5	205,8	181,0	0,0161	181,0	181,1
		4	205,4	0,1843	204,6	205,6	180,8	0,0140	180,8	180,9

Meas. id	Dist. [m]	Sensor	Peak pressure [dB re 1 μPa^2]				SEL [dB re 1 $\mu\text{Pa}^2\text{s}$]			
			Mean	Std	Min	Max	Mean	Std	Min	Max
11	200	1	205,1	0,4141	202,6	205,3	180,6	0,5097	177,4	180,7
		2	204,8	0,4391	202,1	205,0	180,2	0,5067	177,1	180,4
		3	205,1	0,4532	202,4	205,4	180,6	0,5037	177,4	180,8
		4	205,0	0,4349	202,4	205,3	180,5	0,5064	177,3	180,7
12	200	1	204,4	0,7098	202,6	204,7	180,0	1,5526	175,7	180,7
		2	204,0	0,6960	202,2	204,3	179,7	1,5505	175,3	180,4
		3	204,4	0,6682	202,6	204,7	180,1	1,5505	175,7	180,7
		4	204,2	0,6888	202,5	204,6	179,9	1,5480	175,6	180,6
13	200	1	205,5	0,0498	205,4	205,6	180,7	0,0218	180,7	180,8
		2	205,4	0,0441	205,3	205,5	180,6	0,0289	180,5	180,6
		3	205,9	0,0461	205,8	206,0	181,1	0,0334	181,0	181,1
		4	205,6	0,0428	205,5	205,7	180,8	0,0305	180,7	180,9
14	200	1	205,1	0,0548	204,7	205,2	180,7	0,0067	180,7	180,8
		2	204,7	0,0698	204,2	204,8	180,4	0,0081	180,4	180,5
		3	205,0	0,0881	204,4	205,1	180,8	0,0101	180,8	180,9
		4	205,0	0,0744	204,4	205,1	180,7	0,0083	180,7	180,7
15	200	1	205,7	0,0368	205,5	205,8	181,0	0,0107	181,0	181,0
		2	205,5	0,0522	205,2	205,6	180,9	0,0135	180,9	180,9
		3	206,1	0,0756	205,6	206,2	181,5	0,0161	181,4	181,5
		4	205,8	0,0676	205,5	206,1	181,1	0,0150	181,1	181,2

Notes:

- Measurements 3, 5, 12: a small bubble of air caused small fluctuations in the pressure.

Appendix G. IMARES memo 1



memo

FROM

Loes Bolle, Olvin van Keeken, Erwin Winter, Dick de Haan, Cindy van Damme, Jan van der Heul, Victor Simoncelli

DATE

17 September 2010

SUBJECT

The effect of piling noise on the survival of fish larvae – pilot experiments.
IMARES memo 1: Phase 1

Introduction

The aim of this project is to examine the effect of piling noise on the survival of fish larvae by means of laboratory experiments. This approach is novel and requires considerable preparations and testing before the actual exposure experiments can be carried out. These preparations were carried out during the first phase of the project and are documented in 4 memo's (3 TNO memo's and this memo).

An overview of the activities carried out during the first phase:

- Definition of the acoustic signals including a discussion on how representative of pile driving noise these signals can be made (TNO memo 1)
- Design of the experimental set-up (TNO memo 1 & 2)
- Construction of the experimental set-up (TNO memo 3)
- Acoustic testing of the experimental set-up (TNO memo 3)
- Obtaining fish larvae (this memo)
- Obtaining approval by the DEC (Animal Experiments Commission) (this memo)
- Preparation laboratory facilities (this memo)
- Development protocol for handling larvae, maintaining larvae and scoring survival (this memo)
- Estimation larval mortality (this memo)
- Development experimental design (this memo)

The first phase will be completed with a go/no-go decision before the second phase (i.e. the actual exposure experiments) is started. The decision will be based on an evaluation of the feasibility of:

- Generating loud impulse sounds in an experimental setup without distortion due to reflections.
- Generating artificially sound which is representative of the noise from a typical offshore piling installation for a steel mono-pile wind turbine foundation, at distances of 100-2000m.
- Experiments with fish larvae without high mortality due to the handling of larvae during the experiment.

Fish larvae

In principle, larvae can be obtained from 3 sources: catching live larvae, rearing larvae in the laboratory and commercial hatcheries.

Catching larvae is not a realistic option, because it is impossible to catch large amounts of larvae in a healthy state during ichthyoplankton surveys.

Larvae can be reared in the laboratory; this has been done successfully for a number of species. Laboratory rearing requires a major effort: ripe adults are caught in the spawning season, eggs and sperm are collected from these ripe adults, eggs are fertilised *in vitro* and then reared to the larval stage. Laboratory rearing is not considered to be a realistic option for this pilot study in view of the costs involved and the limited time frame in which larvae can be made available this way.

Larvae can be obtained in large numbers and at relatively low costs through commercial hatcheries. For this pilot study we choose sole (*Solea solea*) larvae obtained from a hatchery in IJmuiden (SOLEA BV), because of the high frequency of spawning episodes in this hatchery and for practical reasons (quick and easy delivery of larvae due to close connections with IMARES). The multiple spawning episodes (approximately once in 6-8 weeks) increases the time-frame in which experiments can be carried out. However, the duration of the pelagic larval stages is short and larvae of a certain stage are only available in restricted periods (few days to 1 week). Furthermore, the SOLEA spawning episodes are not planned on a regular basis, but in response to the demand by commercial customers, which complicates planning of experiments. The onset of a spawning episode is usually planned a few weeks in advance, but the precise date when larvae of a certain age are available depends on several factors including temperature regime, condition of the adult stock and feeding success.

Hatchery reared larvae can also be obtained for other species (e.g. sea bass), but this pilot study will be limited to one species, i.e. sole. Consequently, conclusions on inter-specific differences in the impact of piling noise can not be given. For adult fish it has been shown that the impact of sound depends on fish species and fish size (Hastings & Popper 2005). We expect that inter-specific differences will be smaller in the larval stage as physiological differentiation between species is less in the larval stage.

DEC

Approval by the DEC (Animal Experiments Commission) has been granted for the use of 1500 larvae. This number was based on the original plan in the tender of this project. In the meanwhile the project team has decided to reduce the period of effect measurements in a large proportion of the experiments to enable more experiments. Hence more larvae will be required. Although formally an approval is only required in the case of experiments with larvae after the yolk-sac phase, the DEC has been informed about our intention to increase the number experiments.

Laboratory facilities

Laboratory facilities (such as aquaria, climate chambers and clean/filtered sea water), which are required for maintaining fish larvae and maintaining the copepod cultures used to feed fish larvae, are installed at IMARES.

The larvae per delivery (spawning event) will initially be kept in 1 container to avoid different environmental circumstances. The temperature in the hatchery is lower than the ambient temperature in

the IMARES laboratory, so an acclimatisation period is required (at least 1 day). Batches of larvae will be prepared prior to the experiments, to minimize handling time during the experiment. Originally we intended to separate the batches by small floating pens placed in one large holding tank, but the experience gained during the test trials showed that contact with netting should be avoided to minimise mortality. The batches will therefore be kept in small containers.

Test trials

Several test trials, i.e. experiments without exposure to noise, have been carried out prior to the actual exposure experiments.

During the first test trial the procedures for handling larvae were optimised to ensure minimal mortality due the experiment itself. Furthermore a protocol for scoring survival was developed.

Mortality due to handling can be minimized if any contact with the larvae is avoided, i.e. all transferring of larvae should be done within water and all movements of water containing larvae should be done very slowly and carefully. If these handling techniques are applied then the mortality of yolk-sac larvae on the short-term (3 days) is low (<5%). These findings led to a change in the plans on how to insert larvae in the test chamber of the experimental set-up: the larvae will be put directly into the water-filled test chamber in stead of inserting a floating pen or a plastic bag with water and larvae. This approach facilitates the removal of air bubbles from the test chamber, but care has to be taken that the water temperature in the test chamber remains equal to that in the larvae containers.

During the first test trial we discovered that the transition from yolk-sac to feeding is a critical phase, irrespective of any handling. High mortality rates occurred, probably due to poor timing of feeding the larvae. Maintaining larvae after the yolk-sac stage proves to be time-consuming (food items have to be provided and removed once a day). Based on these experiences we have reconsidered the experimental design: we will limit the number of larvae batches maintained for a longer period after the experiment, which enables us to do more experiments on short-term effects.

Survival of larvae will be scored by visual inspection. Originally we envisaged image-analyses of the mobility of larvae to determine if a larva is dead or alive, but it turns out that mobility is not a good criterion as live larvae can be quite immobile. Most dead larvae can easily be recognized by sight and in case of doubt the heart-beat or respiratory activity is checked using a microscope or magnifying glass.

During the second test trial the potential accumulation of larvae at the surface was examined, as this may have consequences for the experimental set-up. The results showed that accumulation of larvae at the surface is limited and can further be limited by the selection of larvae. Hence, potential bias due to heterogeneous distribution and the risk of losing larvae through the top valve of the set-up is limited.

Short-term mortality was estimated more precisely during the second test trial. Three batches of larvae were treated in the same way, i.e. simulating the handling which will be required during the experiments. Each batch consisted of 25 larvae, i.e. the sample size which will be used for the first trial with exposures. The age of the larvae at onset of the experiment was 2-3 days (yolk-sac stage). The larvae were not fed. Mortality was scored after 5 days. Two larvae died in 1 of the 3 batches, no mortality occurred in the other 2 batches. This gives an average mortality of 3% with a standard deviation of 5%.

During the third test trial we focussed on optimising the procedures for maintaining larvae after the yolk-sac stage. The optimised protocol is described in the following section.

Short-term and long term mortality were estimated during the third test trial. Three batches of larvae (batch size=25, age at onset experiment=3 days) were maintained under *ad libitum* food conditions until approximately 50% of the larvae had reached metamorphosis, which was after 16 days. These 3 batches were not exact replicates because the way of providing and removing food differed between the batches. Average mortality was 4% (sd=4%) after 5 days and 11% (sd=12%) after 16 days. These mortality rates are considered to be low, i.e. much lower than natural mortality in the field. Although average mortality was low, variability between batches was high with no apparent explanation. The low mortality rate is encouraging for the actual sound exposure experiments, but the high variability between (almost) identical treatments may indicate that we need more replicates in the final exposure trials.

Until now we had not considered introducing overpressure (water pressure) in the experimental set-up of laboratory experiments. Water pressure may be an important factor in the effect of sound on fish (larvae) and overpressure can be incorporated in the experimental set-up. However, applying overpressure quickly may affect the survival of larvae; larvae may need an acclimatisation period for changes in water pressure as they do for changes in temperature. Before introducing overpressure as a factor in the actual exposure experiments, a test trial is required to examine the effect of changes in pressure. A separate test chamber has been developed for this purpose as the experimental set-up is not yet available. The pressure test trial will be carried out as soon as larvae are available.

The next spawning episode is expected to take place in the week of 20-24 September. This raises the question whether the first sound exposure trial should be postponed until after the 4th test trial or whether the first sound exposure should be carried out without or with low overpressure.

Protocol

For experiments with yolk-sac larvae, recently hatched larvae (one day old) are selected at SOLEA and taken to IMARES. For post yolk-sac experiments, larvae are selected 2 days before the experiments. The larvae are kept for at least 1 day in the transportation container, to acclimatise them to the ambient temperature in the IMARES laboratory.

The larvae are taken from the transportation container with a glass measuring cup. From this cup the larvae are selected and divided into batches. Each batch is placed into a small container with 500ml water. As larvae are vulnerable to mechanic damage, no aeration will be used in the batch-containers to reduce the chance of larvae hitting the walls.

When selecting the larvae from the glass measuring cup, larvae are taken from the water column and not from the surface. Larvae floating at the surface tend to remain at the surface (test trial results). Selection of surface larvae would increase the risk of an heterogeneous distribution of larvae in the test chamber and loss of larvae through the top valve of the experimental set-up.

Larvae are transported to and from different water bodies using a plastic pipette, from which the front part is cut off to increase the size of the opening. This method minimises mortality due to handling. A cut-off pipette is used to transport the larvae from the glass measuring cup to the batch-containers and from the batch-containers to the test chamber. To retrieve the larvae from the test chamber an extended pipette is required.

The duration of the yolk-sac stage (at ambient temperature in the IMARES laboratory) is 3-4 days. The larvae clearly feed at an age of 4 days (after hatching). In principle, food is provided from 3 days after

hatching onwards. But in the case of experiments with yolk-sac larvae, in which only the short-term effect of exposure is monitored (i.e. the age of the larvae at the end of the monitoring period ≤ 5 days), the larvae will not be fed.

Young larvae are fed with 1-day-old copepods. Older larvae are fed with 2-day-old 'enriched' copepods; these copepods have been fed for 1 day with algae to increase the nutritional value and size of the copepods. This diet is sustained until metamorphosis. The food items are provided *ad libitum*.

After feeding has started the water in the containers has to be refreshed each day, partly due to the fact that the containers are not aerated, but mainly due to the necessity of removing old food items. The quickest and most effective way of doing this is by transferring the larvae to a new batch-container holding water of ambient temperature with fresh copepods.

In all experiments, the larvae are examined right after the experiment and after 1-3 days to assess mortality. In a limited number of experiments the larvae are monitored for an extended period.

Survival of larvae is scored by visual inspection. Dead larvae can easily be recognized by sight. Within a day (probably within a few hours) after death, the shape of the larva clearly indicates that the larva is dead (Figure 1). When in doubt, a larva is viewed using a microscope or a magnifying glass to examine the heart-beat and/or respiratory activity.

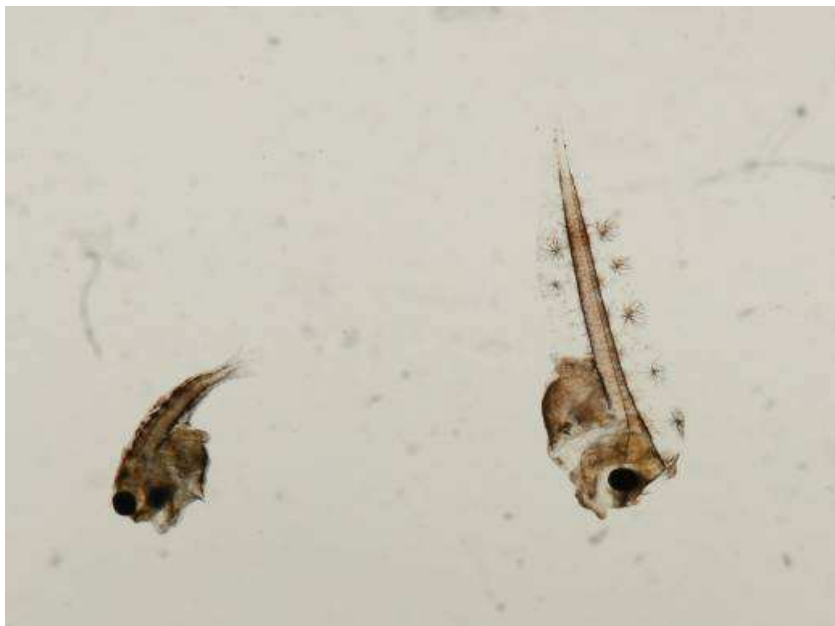

Figure 1. Left: dead larva, right: live larva

The dead larvae and (part of) the live larvae at the end of the monitoring period will be preserved to enable future examination of physiological damage. The larvae will be preserved in 3 ways (to enable both histological and SEM analyses):

- 3.6% formaldehyde solution
- glutaraldehyde-formaldehyde solution
- supercold alcohol (-70°C)

Experimental design

The experiments will be performed at IMARES. The experiments will be supported by TNO in operating the experimental set-up and measuring and analysing the evoked sound levels.

Three trials will be carried out. Each trial consists of ± 20 experiments to be carried out in 1 day. During the 1st trial, the sensitivity range of larvae to various sound parameters will be examined crudely. The results of the 1st trial will be used to focus on relevant sound parameters during the 2nd trial. If all goes well then the 3rd trial can be used to examine the role of biological (age of larvae) and environmental (water depth) factors in the effect of sound on fish larvae. As the results of the previous trial will form the basis for the next trial, 3 spawning events are required to be able to carry out the 3 trials (see paragraph 'fish larvae'). We aim at examining the effect of the variables (at the levels) listed in Table 1.

Table 1. Variables and levels of variables examined during the SMW pilot experiments.

Variables	Levels			Values			
Sound level at distance (m)	6	100	200	400	800	1600	3200
Strokes (no.)	3	1	10	100			
velocity or pressure	2	V	P				
Water pressure (bar)	2	0.5	2				
Age larvae at T=0 (days after hatching)	2	2-3	$\pm 8-9$				

The sound level is expressed in distance to the pile driving site. Each distance corresponds with a certain value for the sound exposure level (SEL) and peak exposure level (see memo 1). The maximum sound level that can be generated by the experimental set-up corresponds to a distance of 100m. Sound measurements within 100m of a pile driving site are not yet available. The larvae will be exposed to single or multiple blasts: 1, 10 or 100 strokes. We choose 3 values for this variable rather than calculating the number of strokes for each distance based on the average current, to be able to test this variable independently. The effect of sound pressure and particle velocity will also be measured independently (see memo 1 and 2).

Two values for the factor age larvae are chosen corresponding to larval stages 1 and 3 (according to Al-Maghazachi & Gibson 1984). Larval stage 1 is the yolk-sac phase. These larvae do not require feeding and are therefore easily maintained and kept alive. Furthermore, the yolk-sac itself may be an organ sensitive to sound pressure or velocity. Larval stage 3 is selected because in this stage the swim bladder is fully inflated (Al-Maghazachi & Gibson 1984). The swim bladder diminishes in stage 4 and completely disappears in stage 5. Metamorphosis is completed by the end of stage 5 (Ryland 1966, Al-Maghazachi & Gibson 1984). The duration of larval stages 1 to 3 is estimated to be approximately 9 days at ambient temperature in the IMARES laboratory, based on a review of temperature dependent development rates presented in Bolle et al. (2005). Development is however also dependent on feeding success.

Two values for the factor water pressure are chosen based on the geographical and vertical distribution of sole larvae. No studies on the vertical distribution of sole larvae have been carried out in the southern North Sea. A North Sea & Irish Sea study on the planktonic stages other fish species shows that, overall, larvae occur in the entire water column with higher concentrations in the top water layers (<25m), but this study also shows inter-specific differences (Conway et al. 1997). Vertical distribution has been examined in other sole populations, but most of these studies focused on the transition from pelagic to demersal life style and only discriminated between the bottom water layer (1-1.5m above seabed) and

the rest of the water column (e.g. Lagardère et al. 1999, Grioche et al. 2000). Only 1 study, carried out in the Bay of Biscay (published in Koutsikopoulos et al. 1991 and Champalbert & Koutsikopoulos 1995), presented data on the distribution of sole larvae in the entire water column. This study showed that the early larval stages (stage 1-2) mainly occur in the bottom half of the water column, whereas the later stages (stage 3-4) occur in the whole water column. A diel vertical migration pattern is observed in which the larvae move up in the water column at night and down during daytime. This pattern was clearly observed in larval stages 3 and 4, but was less evident for the stages 1 and 2. By stage 5, sole larvae disappeared from pelagic catches and were only observed close to the seabed. Sole spawning grounds are further offshore in the Bay of Biscay compared to the North Sea (Arbault et al. 1986, Koutsikopoulos & Lacroix 1992). In the North Sea, sole spawn within the 50m depth contour (Houghton & Riley 1981, Riley et al. 1986, van der Land 1991) and major spawning activity is observed at a water depth of 10-25m (Bolle et al. in prep). Taking into account both the vertical distribution pattern observed in the Bay of Biscay and the geographical distribution of sole spawning in the North Sea, we concluded that sole larvae will certainly occur at a depth of 5m and 20m (i.e. 0.5 and 2 bar overpressure). Furthermore, these 2 values differ sufficiently to test the effect and water depth and they are also realistic for larvae of other fish species.

The response variable that will be measured is mortality. In all experiments, mortality will be measured directly after the experiment and after 1-3 days ($T=0 - 3$ days). In a limited number of experiments mortality will be monitored for an extended period ($T=0 - \pm 10$ days).

During the first trial all experiments, including a control experiment without sound exposure, will be carried in duplo. The sample size for the experiments in the first trial will be set at 25. This number is reduced compared to the original plans in the tender of this project because of the low mortality observed in the test trials.

The levels of the variables will be limited in the first trial compared to Table 1. The age of the larvae will be set at 2 or 3 (yolk-sac stage). Water pressure will be set at 2 bar, if the results of the 4th test trial are available and show that it is possible to increase pressure quickly (i.e. within a few minutes) without affecting the larvae. Otherwise the first trial will be carried out using a low overpressure (0.5 bar). The number of strokes will only be varied between 1 or 100 strokes.

An iterative approach has been chosen for the 1st trial; the results of the first experiment determine the choice of the next exposure. This approach is the most effect way to find the critical sound exposure levels, but it strongly depends on immediate visibility of effects of sound exposure.

We expect to be able to carry out 26 experiments during the first trial (1 day): 1 control experiment in duplo, 6 exposures to sound pressure in duplo, and 6 exposures to particle velocity in duplo. An exposure refers to the combination of the sound level at a certain distance and the number of strokes (1 or 100). A test-scheme has been developed for the first trial (Table 2). This scheme consists of 14 series of exposures. The first exposure in all scenario's is 1 stroke at a sound level corresponding to a distance of 800m. If this has no direct effect then the next exposure is 100m / 1 stroke; if this has no effect then the next exposure is 100m / 100 strokes; etc. This scheme is carried out for both sound pressure as well as particle velocity, as the critical exposure values may be different for pressure and velocity. The test scheme has been worked out for 9 exposures, to be prepared if more than 6 exposures are possible during the first trial.

The left part of Table 2 presents the exposures necessary to determine the critical exposure values for instantaneous effects. The right part of Table 2 lists additional experiments focused on non-instantaneous effects. The emphasis of the latter experiments is on multiple strokes as it is expected

that non-instantaneous effects will mainly be determined by the number of strokes. If all relevant combinations of sound level and number of strokes have been tested then the remaining capacity can be used to fine-tune the dose-effect relationship, or in the case of an effect at a distance of 3200m, further reduce the sound level (scenario's 11-14).

The iterative approach adopted for the first trial depends on the assumption that effects are immediately detectable. If this assumption proves to be untrue then the first trial will consist of the exposures listed in scenario 1.

Table 2. Scenario's for first trial with sound exposures. See text for further explanation.

Scenario	Exp1	Exp2	Exp3	Exp4	Exp5	Exp6	Exp7?	Exp8?	Exp4	Exp5	Exp6	Exp7?	Exp8?	Exp9?
1	800/1	100/1	100/100						400/100	1600/100	3200/100	200/1	400/1	1600/1
2a	800/1	100/1	100/100	800/100	400/100	200/100			-	-	-	1600/100	3200/100	200/1
2b	800/1	100/1	100/100	800/100	400/100	200/100			-	-	-	1600/100	3200/100	200/1
3	800/1	100/1	100/100	800/100	400/100				-	-	1600/100	3200/100	200/1	400/1
4a	800/1	100/1	100/100	800/100	3200/100	1600/100			-	-	-	200/1	400/1	1600/1
4b	800/1	100/1	100/100	800/100	3200/100	1600/100			-	-	-	200/1	400/1	1600/1
5	800/1	100/1	100/100	800/100	3200/100				-	-	200/1	400/1	1600/1	3200/1
6	800/1	100/1	400/1	400/100	200/100				-	-	800/100	1600/100	3200/100	200/1
7a	800/1	100/1	400/1	400/100	200/100	200/1			-	-	-	800/100	1600/100	3200/100
7b	800/1	100/1	400/1	400/100	200/100	200/1			-	-	-	800/100	1600/100	3200/100
8a	800/1	100/1	400/1	400/100	800/100	200/1			-	-	-	1600/100	3200/100	1600/1
8b	800/1	100/1	400/1	400/100	800/100	200/1			-	-	-	1600/100	3200/100	1600/1
9a	800/1	100/1	400/1	400/100	800/100	3200/100	1600/100	200/1	-	-	-	-	-	1600/1
9b	800/1	100/1	400/1	400/100	800/100	3200/100	1600/100	200/1	-	-	-	-	-	1600/1
9c	800/1	100/1	400/1	400/100	800/100	3200/100	1600/100	200/1	-	-	-	-	-	1600/1
9d	800/1	100/1	400/1	400/100	800/100	3200/100	1600/100	200/1	-	-	-	-	-	1600/1
10a	800/1	100/1	400/1	400/100	800/100	3200/100	200/1		-	-	-	-	1600/1	3200/1
10b	800/1	100/1	400/1	400/100	800/100	3200/100	200/1		-	-	-	-	1600/1	3200/1
11a	800/1	100/1	400/1	1600/100	800/100				-	-	3200/100	1600/1	3200/1	*
11b	800/1	100/1	400/1	1600/100	800/100				-	-	3200/100	1600/1	3200/1	*
12a	800/1	100/1	400/1	1600/100	3200/100				-	-	1600/1	3200/1	*	*
12b	800/1	100/1	400/1	1600/100	3200/100				-	-	1600/1	3200/1	**	**
13a	800/1	1600/1	1600/100						3200/100	3200/1	*	*	*	*
13b	800/1	1600/1	1600/100	3200/100					-	3200/1	*	*	*	*
13c	800/1	1600/1	1600/100	3200/100					-	3200/1	**	**	**	**
14a	800/1	1600/1	3200/1	3200/100					-	*	*	*	*	*
14b	800/1	1600/1	3200/1	3200/100					-	**	**	**	**	**
14c	800/1	1600/1	3200/1						3200/100	**	**	**	**	**

no direct effect
 direct effect

* fine-tune dose-effect relationship
 ** further reduce SEL until no direct effect, then fine tune dose effect relationship

References

Al-Maghazachi SJ, Gibson R (1984) The developmental stages of turbot, *Scophthalmus maximus*. Journal of Experimental Marine Biology and Ecology 82:35-51

Arbault S, Camus P, Le Bec C (1986) Estimation of the common sole (*Solea vulgaris* Quensel 1806) spawning stock by egg survey in the Bay of Biscay. J Appl Ichthol 4:145-156

Bolle LJ, Dickey-Collas M, Erftemeijer PLA, van Beek JKL, Jansen HM, Asjes J, Rijnsdorp AD, Los HJ (2005) Transport of fish larvae in the southern North Sea. Impacts of Maasvlakte 2 on the Wadden Sea and North Sea coastal zone (track 1, part IV: fish larvae) & baseline study MEP Maasvlakte 2 (lot3b: fish larvae). RIVO Report C072/05, 144 pp.
www.verkeerenwaterstaat.nl/kennisplein/page_kennisplein.aspx?DossierURI=tcm:195-17870-4&Id=325640

Bolle LJ, Rijnsdorp AD and others (in prep) Spawning grounds of common sole (*Solea solea*) in the North Atlantic. ICES J Mar Sci

Champalbert G, Koutsikopoulos C (1995) Behaviour, transport and recruitment of Bay of Biscay sole (*Solea solea*): laboratory and field studies. J mar biol Ass UK 75:93-108

Conway DVP, Coombs SH, Smith C (1997) Vertical distribution of fish eggs and larvae in the Irish Sea and southern North Sea. ICES J Mar Sci 54:136-147

Grioche A, Harlay X, Koubbi P, Lago LF (2000) Vertical migrations of fish larvae: Eulerian and Lagrangian observations in the Eastern English Channel. Journal of Plankton Research 22:1813-1828

Hastings M & Popper A (2005). Effects of sound on fish. Unpublished report prepared for California Department of Transportation. www.dot.ca.gov/hq/env/bio/files/Effects_of_Sound_on_Fish23Aug05.pdf.

Houghton RG, Riley JD (1981) Sole (*Solea solea*) spawning areas. In Lee AJ, Ramster JW (Eds) Atlas of the seas around the British Isles, MAFF, London.

Koutsikopoulos C, Fortier L, Gagne JA (1991) Cross shelf dispersion of Dover sole (*Solea solea*) eggs and larvae in Biscay Bay and recruitment to inshore nurseries. Journal of Plankton Research 13:923-945

Koutsikopoulos C, Lacroix N (1992) Distribution and abundance of sole (*Solea solea* (L.)) eggs and larvae in the Bay of Biscay between 1986 and 1989. Netherlands Journal of Sea Research 29:81-91

Lagardère F, Amara R, Joassard L (1999) Vertical distribution and feeding activity of metamorphosing sole, *Solea solea*, before immigration to the Bay of Vilaine nursery (northern Bay of Biscay, France). Environmental Biology of Fishes 56:213-228

Riley JD, Symonds DJ, Woolner LE (1986) Determination of the distribution of the planktonic and small demersal stages of fish in the coastal waters of England, Wales and adjacent areas between 1970 and 1984. Fish Res Tech Rep No 84:1-23

Ryland JS (1966) Observations on the development of larvae of the plaice, *Pleuronectes platessa* L., in aquaria. J Cons perm int Explor Mer 30:177-195.

van der Land MA (1991) Distribution of flatfish eggs in the 1989 egg surveys in the south-eastern North Sea, and mortality of plaice and sole eggs. Neth J Sea Res 27:277-286

Appendix H. IMARES memo 2



memo

FROM

Loes Bolle, Marco Lohman, Jan van der Heul, Tim Huijser

DATE

16 December 2010

SUBJECT

The effect of piling noise on the survival of fish larvae – pilot experiments.
IMARES memo 2: Preliminary results phase 2

Introduction

The aim of this project is to examine the effect of piling noise on the survival of fish larvae by means of laboratory experiments. This approach is novel and requires considerable preparations and testing before the actual exposure experiments can be carried out. These preparations were carried out during the first phase of the project and are documented in 4 memo's (TNO memo's 1-3 and IMARES memo 1).

The "go" decision for the 2nd phase of the project was taken on 20 September 2010. Since then 3 trials and 1 additional test trial have been carried out. The preliminary results of these trials are presented in the this memo. Furthermore, an update of the procedures for handling larvae, maintaining larvae and scoring mortality, based on experiences obtained during the 2nd phase of the project, is presented.

Procedures for handling larvae, maintaining larvae and scoring mortality (updated)

Batches of eggs are obtained from an hatchery. The eggs and larvae are reared to the required developmental stage in large cultivation chambers at the IMARES laboratory. The temperature is slowly raised to the ambient temperature in the IMARES laboratory. Advantage of rearing the larvae at IMARES, rather than obtaining larvae shortly before the experiment, is that the developmental stage can be manipulated by temperature adjustments.

Ample larvae are carefully collected from the cultivation chamber using a small container. The required number of larvae are selected from this container and inserted into the test chamber of the experimental set-up. After the treatment, the larvae are transferred to a small container and examined for instantaneous effects. The water in the test chamber is refreshed before the next experiment is carried out.

The larvae are transferred to and from different water bodies using a plastic pipette, from which the front part is cut off to increase the size of the opening. This method minimises mortality due to handling.

After the experiments, the batches of larvae are held separately in small containers for a period of 10-12 days. Larvae are vulnerable to mechanic damage, therefore no aeration is used in these small batch-containers. The water in the containers is refreshed each day, because the containers are not aerated, and because of the necessity of removing old food items. The quickest and most effective way of doing this is by transferring the larvae to a new batch-container. Whilst doing this the mortality rate is scored.

The duration of the yolk-sac stage (at ambient temperature in the IMARES laboratory) is 3-4 days; the larvae clearly feed at an age of 4 days (after hatching). Food is provided each day from 3-4 days after hatching onwards. Young larvae are fed with 1-day-old copepods. Older larvae are fed with 2-day-old 'enriched' copepods; these copepods have been fed for 1 day with algae to increase the nutritional value and size of the copepods. This diet is sustained until metamorphosis. The food items are provided *ad libitum*.

Survival of larvae is scored by visual inspection. Dead larvae can easily be recognized by sight. Within a day (probably within a few hours) after death, the shape of the larva clearly indicates that the larva is dead (Figure 1 in IMARES memo 1). When in doubt, a larva is viewed using a microscope or a magnifying glass to examine the heart-beat and/or respiratory activity.

The live larvae at the end of the monitoring period are preserved to enable future examination of physiological damage. The larvae are preserved in 3.6% formaldehyde solution for histology or in a glutaraldehyde-formaldehyde solution. This preservation method allows both light microscopy and SEM analyses.

Test trial 4

Initially we had not considered introducing overpressure (water pressure) in the experimental set-up, but recent work (presented at an international conference in August 2010) showed that the effect of sound may be proportional to water pressure. The design of the experimental set-up was changed to enable overpressure. However, applying overpressure rapidly may affect the survival of larvae. The larvae may need an acclimatisation period for changes in water pressure as they do for changes in temperature. Before introducing overpressure as a factor in the actual exposure experiments, a test trial is required to examine the effect of changing overpressure. A test chamber has been developed by IMARES to test this.

Two larval stages were exposed to several treatments to examine the effect of overpressure (Table 1). The larvae exposed to overpressure showed a higher mortality rate than the control group (Figure 1). The difference with the control group is considered to be small enough to risk this source of additional mortality in the actual sound exposure experiments.

Table 1. Treatments in test trial 4.

Stage larvae	Treatment	Overpressure (bar)	Duration pressure (min)	No. of replicates
1	control	0	21	2
1	stepwise 0.5 bar	2	21	2
1	instantaneous	2	21	2
1	instantaneous	3	21	2
2	control	0	21	2
2	instantaneous	3	21	2

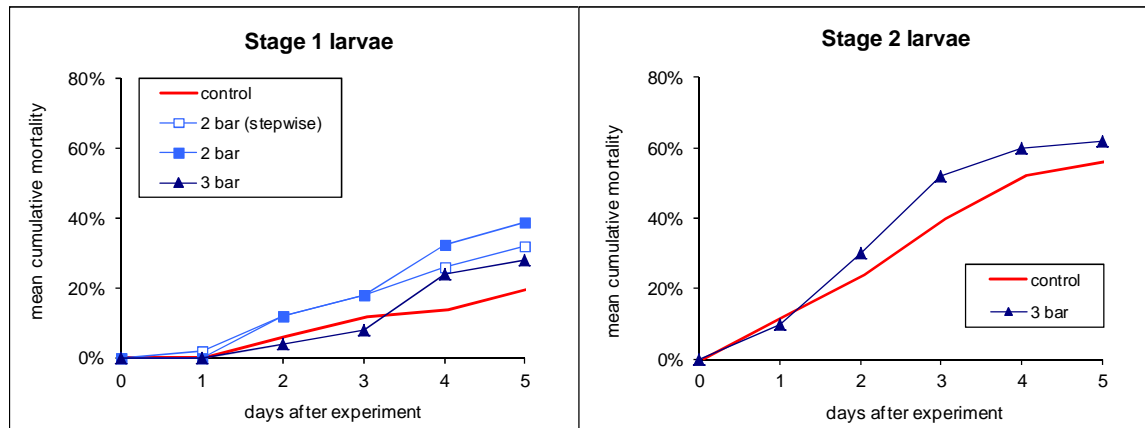

Figure 2. Mean cumulative mortality rates for each treatment 0-5 days after the experiment.

Trial 1

As little is known about the critical values for sound parameters with regard to larval survival, the aim of the first trial was to examine the sensitivity range. Hence we choose to maximise the number of exposures and minimise the number of replicates. A test scheme was designed in which each exposure depended on the results of the previous exposure (IMARES memo 1). This iterative approach is the most effective way to find critical sound exposure levels, but it depends on immediate visibility of the effects of sound exposure.

It was not possible to carry out the 4th test trial before the first sound exposure trial, due to the availability of fish larvae and the duration of the project. The first trial was therefore carried out with a small overpressure (0.5 bar). Young fish larvae (stage 1, yolk-sac stage) were used in the first trial. All experiments were carried out in duplo. The batch size for each experiment was 25 (\pm 2) larvae.

No immediately visible effects were observed, therefore scenario 1 of the test scheme (IMARES memo 1) was followed. The pressure excitation exposure representing 100m and 100 strokes was replaced by an exposure representing 100m and 50 strokes because of the risk of overheating the set-up. The number of experiments possible in 1 day was lower than anticipated; 6 exposure and 2 control experiments were carried out in duplo (Table 2). The first control group received exactly the same treatment as the exposure groups. The second control group was not inserted in the test chamber but otherwise received the same treatment. The sound parameters for each distance and number of strokes (Table 2) are estimated based on a 'typical' North Sea piling event (Q7 characteristics: 4m diameter pile, sandy bottom, 20m depth; TNO memo 1).

Table 2. Treatments in trial 1.

Treatment	Over-pressure	Velocity or pressure excitation	Distance	No. of strokes	Peak pressure	SEL	Peak velocity	Integrated velocity	No. of replicates
	bar		m		dB re 1 uPa ²	dB re 1 uPa ² s	dB re 1 (nm/s) ²	dB re 1 (nm/s) ² s	
control 1	0				0	0	0	0	2
control 2	0.5				0	0	0	0	2
sound exposure	0.5	P	800	1	197	173	133	108	2
sound exposure	0.5	P	100	1	211	187	147	122	2
sound exposure	0.5	P	100	50	211	204	147	139	2
sound exposure	0.5	V	800	1	183	158	133	110	2
sound exposure	0.5	V	100	1	197	172	147	124	2
sound exposure	0.5	V	100	100	197	192	147	144	2

No instantaneous effects were observed. Mortality rates were scored daily until 12 days after the experiment. All experiments (instead of a selection, i.e. contrary to the plans presented in IMARES memo 1) were monitored for a period of 12 days. No clear differences were observed between the different treatments during this period (Figure 3, left panels) Variability between batches with the same treatment was high (illustrated by the error bars in the right panels of Figure 3). Preliminary statistical analyses (ANOVA) show no significant differences between the treatments after 12 days. Final statistical analyses (mixed modelling) have not been carried out yet.

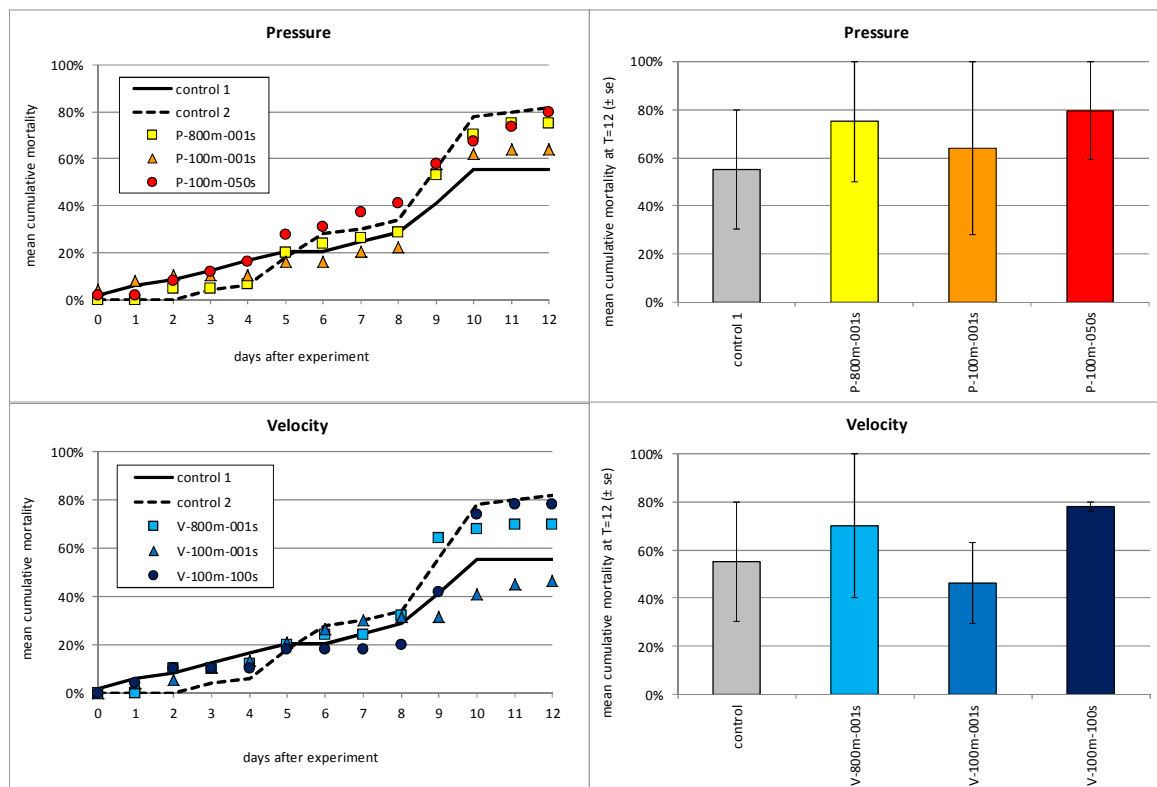

Figure 3. Trial 1 results. Left: mean cumulative mortality rate for each treatment 0-12 days after experiment. Right: mean cumulative mortality rates (\pm se) for each treatment 12 days after the experiment (95% confidence limit = $12.7 \cdot se$ at $n=2$).

Trial 2

High 'batch variability' (variability between batches with the same treatment) was observed in the previous trials. The number of replicates required to statistically assess a certain difference between treatments increases with an increase in batch variability. Therefore the number of replicates for each treatment was increased in the 2nd trial, at the expense of the number of exposures. The iterative approach was reduced to 1 exposure representing 100m and 1 stroke and 2 follow-up scenario's. Each scenario consisted of 4 replicates of 6 treatments (4 exposures and 2 controls) in randomised sequence. The randomisation was applied to avoid bias due to potential serial effects in batch variability. A 5th exposure was defined in both scenario's in case time allowed additional experiments.

The intention was to carry out all experiments employing 2 bar overpressure, however, due to technical problems we had to change the overpressure to 0 bar. Stage 2 larvae were used in the second trial. The batch size for each experiment was 25 (± 2).

No immediately visible effects were observed, therefore the scenario consisting of high sound exposures was followed (Table 3). The number of experiments which could be carried out in 1 day was higher than during the previous trial (because of experience gained, increased size of larvae and omission of static pressure). Four exposure and 2 control experiments were carried out in 4-fold and randomised sequence. A 5th exposure (100m, 100 strokes) was carried out in 4-fold at the end of the day. The sequence of monitoring was randomised over all treatments. The first control group received exactly the same treatment as the exposure groups. The second control group was not inserted in the test chamber but otherwise received the same treatment. The sound parameters for each distance and number of strokes (Table 3) are estimated based on a 'typical' North Sea piling event (Q7 characteristics: 4m diameter pile, sandy bottom, 20m depth; TNO memo 1).

Table 3. Treatments in trial 2.

Treatment	Over-pressure	Velocity or pressure excitation	Distance	No. of strokes	Peak pressure	SEL	Peak velocity	Integrated velocity	No. of replicates
	bar		m		dB re 1 uPa ²	dB re 1 uPa ² s	dB re 1 (nm/s) ²	dB re 1 (nm/s) ² s	
control 1	0				0	0	0	0	4
control 2	0				0	0	0	0	5
sound exposure	0	P	200	200	206	205	142	140	4
sound exposure	0	P	100	50	211	204	147	139	4
sound exposure	0	P	100	100	211	207	147	142	4
sound exposure	0	V	200	200	192	190	142	142	4
sound exposure	0	V	100	100	197	192	147	144	4

No instantaneous effects were observed. Mortality rates were scored daily until 10 days after the experiment, for all experiments. The only exposure which appeared to have an effect on mortality after 5-10 days was the highest pressure exposure, corresponding to a distance of 100m and 100 strokes (Figure 4, left panels). After 10 days, a cumulative mortality rate of 80% was observed for this exposure compared to 60% in the control group (i.e. 50% of the larvae which survive 'natural mortality' are killed due to noise). Preliminary statistical analyses indicate that the difference is not significant (ANOVA, P=0.14). Final statistical analyses (mixed modelling) have not been carried out yet. A larger number of replicates is necessary to be able to assess the statistical significance of a difference of this magnitude, given the high variability between batches with the same treatment.

If significant, the results indicate a sharp threshold at 207 dB (cumulative SEL), which is 24 dB above the threshold suggested by the US Caltrans Fisheries Hydro-acoustic Working Group for fish <2 gram (Oestman et al. 2009). If significant, the hypothesis of 100% mortality up to a distance of 1000m from the pile driving site (as assumed in the Appropriate Assessment Dutch offshore wind farms, Prins et al. 2009) can be rejected.

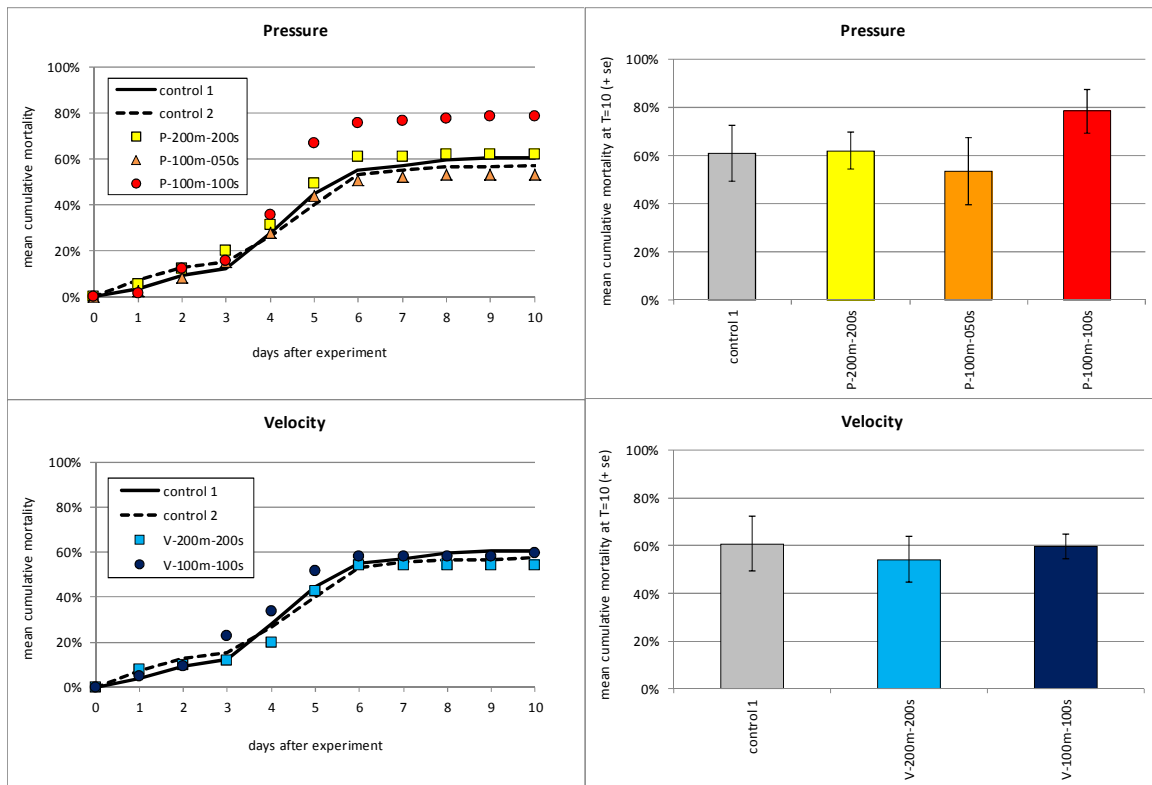

Figure 4. Trial 2 results. Left: mean cumulative mortality rate for each treatment 0-10 days after experiment. Right: mean cumulative mortality rates (\pm se) for each treatment 10 days after the experiment (95% confidence limit = $3.2 \cdot se$ at $n=4$)

Trial 3

The same approach was chosen for trial 3 as for trial 2, that is 1 exposure representing 100m and 1 stroke and 2 follow-up scenario's. The number of replicates for each treatment was further increased to 5 (95% confidence limit = $2.8 \cdot se$ at $n=5$). Like in trial 2, 4 exposures and 2 controls were carried out in randomised sequence, and a 5th exposure was defined in case time allowed additional experiments.

Stage 3 larvae were used in the third trial. In this larval stage the swim bladder is maximally inflated and hence a higher sensitivity to sound waves is expected compared to the larval stages used in the previous trials. The 2nd trial actually already aimed at stage 3 larvae but the development rates proved to be lower than expected based on a literature review (IMARES memo 1). A sample of larvae was examined on the day of the experiments and the stages ranged from 3a to 4a with the majority of larvae in stage 3b (stages according to Al-Maghazachi & Gibson 1984).

The batch size for each experiment was 28 (± 2). All experiments were carried out with no overpressure to be consistent with the previous trials.

No immediately visible effects were observed, therefore the scenario consisting of high sound exposures was followed (Table 4). Four exposure and 2 control experiments were carried out in 5-fold and randomised sequence. A 5th exposure (100m, 10 strokes) was carried out in 4-fold at the end of the day. The sequence of monitoring was randomised over all treatments. The first control group received exactly the same treatment as the exposure groups. The second control group was not inserted in the test chamber but otherwise received the same treatment. The sound parameters for each distance and number of strokes (Table 4) are estimated based on a 'typical' North Sea piling event (Q7 characteristics: 4m diameter pile, sandy bottom, 20m depth; TNO memo 1). The first 4 exposures consisted of 2 pressure excitation exposures with different peak pressure levels and the same cumulative SEL, and 2 velocity excitation exposures with different peak velocity and the same integrated velocity. The additional exposure was a pressure excitation exposure in which the cumulative SEL was reduced by 10 dB compared to the previous pressure excitation exposures.

Table 4. Treatments in trial 3.

Treatment	Over-pressure	Velocity or pressure excitation	Distance	No. of pulses	Peak pressure	SEL	Peak velocity	Integrated velocity	No. of replicates
	bar		m		dB re 1 uPa ²	dB re 1 uPa ² s	dB re 1 (nm/s) ²	dB re 1 (nm/s) ² s	
control 1	0				0	0	0	0	5
control 2	0				0	0	0	0	5
sound exposure	0	P	100	10	211	197	147	132	4
sound exposure	0	P	200	300	206	207	142	142	5
sound exposure	0	P	100	100	211	207	147	142	5
sound exposure	0	V	200	300	192	192	142	144	5
sound exposure	0	V	100	100	197	192	147	144	5

No instantaneous effects were observed. Mortality rates will be scored daily until 10-12 days after the experiment, for all experiments. These results are not yet available.

References

Al-Maghazachi SJ, Gibson R (1984) The developmental stages of turbot, *Scophthalmus maximus*. Journal of Experimental Marine Biology and Ecology 82:35-51

Oestman R, Buehler D, Reyff JA, Rodkin R (2009) Sacramento: California Department of Transportation. 'CALTRANS Technical Guidance for Assessment and Mitigation of the Hydroacoustic Effects of Pile Driving on Fish'

Prins TC, Van Beek JKL, Bolle LJ (2009) Modellschatting van de effecten van heien voor offshore windmolenparken op de aanvoer van vislarven naar Natura 2000 gebieden. Report No. Z4832, Deltares.

Appendix I. IMARES memo 3



memo

FROM

Loes Bolle, Stijn Bierman

DATE

2 February 2011

SUBJECT

The effect of piling noise on the survival of fish larvae – pilot experiments.
IMARES memo 3: Statistical power analysis & Proposal additional trials

Introduction

Three trials have been carried out to examine the effects of piling noise on the survival of fish larvae. Mortality rates were scored directly after the experiment and daily until 10-12 days after the experiment. Different larval stages were used in each trial (stage 1-3). The number of replicates was increased from 2 in trial 1 to 4 in trial 2, and 5 in trial 3. The treatments and further details of the test scheme and monitoring scheme are presented in the December progress report (Bolle et al. 2010).

No clear effects were observed in the 1st and 3rd trial. In the 2nd trial (stage 2 larvae), the highest pressure exposure appeared to have an effect on mortality after 5-10 days. After 10 days, a cumulative mortality rate of 80% was observed for this exposure, compared to 60% in the control group. A difference of this magnitude – i.e. 50% of the larvae which survive 'natural mortality' are killed due to noise – is considered to be relevant. The difference, however, was not statistically significant. A larger number of replicates is necessary to be able to assess the statistical significance of a difference of this magnitude, given the large variability between batches with the same treatment. Furthermore, a difference of this magnitude cannot be excluded for the other larval stages (stage 1 and 3) without additional experiments.

A statistical power analysis was carried out to estimate the number of replicates required to be able to assess the statistical significance of an effect with a magnitude as observed during the second trial.

Methods

The statistical power analysis was based on a mixed model with random effects. The logit transformed probability of death (p in treatment i and batch j) was modelled as a function of treatment and random batch effect (α) (equation 1). The number of dead larvae (k) is binomially distributed depending on the probability of death (p) and the number of larvae at the beginning of the experiment (N) (equation 2). The random batch effect (α) is normally distributed (equation 3).

- (1) $\text{logit}(p_{it}) = \text{treatment}_i + \alpha_i$
- (2) $k_{it} \sim \text{Bin}(p_{it}, N_{it})$
- (3) $\alpha_i \sim N(0, \sigma^2)$

The variance was estimated in SAS (glimmix procedure) and the power was estimated in R (based on 1000 iterations for each separate analysis).

The power (probability of detecting an effect significantly at the 95% level) depends on the magnitude of the effect to be detected. The magnitude of an effect considered to be relevant in this study is the magnitude observed in trial 2: the number of larvae surviving in the exposure group = 50% of the number of larvae surviving in the control group. This effect is further referred to as a "50% effect". Note that with this definition of the effect to be detected, the relative difference between the exposure group and control group depends on the mortality rate in the control group.

Both the mortality in the control group, as well as the variance observed between batches with the same treatment, varied between trials and increased with duration of monitoring. Therefore separate power analyses were carried out for each trial (i.e. each larval stage) and for 2 durations of monitoring (T=5 or 10 days). In trial 3 (stage 3) hardly any larvae had died after 5 days, therefore only T=10 days was included in the analyses. The power was computed for 25 or 50 larvae per batch, and for 5, 10, 15, 20 or 30 replicates per treatment.

In trial 1 at T=5 and in trial 3, the postulated effects were higher than the observed effects. As batch variance increases with mortality, using the observed variance would underestimate the number of replicates required. Therefore the batch variance observed in trial 2 at T=10 was used in these cases.

A statistical analysis to estimate the power to *detect* a certain effect is not the same as an analysis to estimate the power to *exclude* the same effect. Therefore a second series of analyses was carried out to estimate the power of excluding a 50% effect if the actual effect is small (set at 10%).

A total of 100 computations of power (see Details of statistical power analyses) were carried out to address aspects described above.

Results

The results of the statistical power analyses are presented in detail below and summarised in this section.

The probability of detecting a 50% effect (as described above) is low with 5 replicates and 25 larvae per batch, i.e. the number of larvae per batch and the maximum number of replicates used in the first 3 trials.

Due to the high batch variance, doubling the number of replicates improves the power far more than doubling the number of larvae per batch.

Random batch variance increases with duration of the experiment. Hence, the statistical power for detecting a difference between the control group and the exposure group is higher at T=5 than at T=10. This provides an argument for reducing the monitoring period to 5 days. However, if the effect occurs after 5 days than it will be missed if the monitoring period is reduced. Furthermore, extended

monitoring provides additional confidence in the observed effects despite that is not quantified in the statistical significance.

Fifteen replicates for each treatment and 25 larvae per batch gives a high probability of detecting a 50% effect significantly at the 95% level (power estimates at T=5 for stage 1 and 2 larvae and at T=10 for stage 3 larvae):

	Stage 1	Stage 2	Stage 3
Power	96%	97%	100%

Fifteen replicates for each treatment and 25 larvae per batch also gives a reasonably high probability of excluding a 50% effect if the real effect is small (power estimates at T=5 for stage 1 and 2 larvae and at T=10 for stage 3 larvae):

	Stage 1	Stage 2	Stage 3
Power	78%	76%	85%

This means that, with 15 replicates, and given the postulated 50% effect and the estimated variation between batches, there is only a small risk (<5%) that an estimated treatment effect will not be significant at the 95% level. However, there is still some risk (estimated at between 24% for stage 2 and 15% for stage 3) that a treatment effect as large as 50% cannot be excluded at the 95% significance level if the true effect is only small. We propose that these risks are acceptable and therefore that 15 replicates are sufficient for additional trials.

The analyses suggest that a lower number of replicates may be sufficient for stage 3 larvae. This is a result of the low mortality observed in the control group in the 3rd trial and, consequently, the relatively large difference between exposure and control group in the case of a 50% effect. If this low control-group-mortality is solely related to larval stage, then similar values can be expected in future experiments using stage 3 larvae. However, other factors (such as egg quality) are also likely to play a role and control-group-mortality may be higher in future experiments. Therefore 15 replicates is also advised for stage 3 larvae.

Conclusion

The statistical power analyses show that the significance of a 50% effect can be tested with 15 replicates (25 larvae per batch). Based on the experience gained during the first 3 trials we know it is possible to carry out 30 experiments (with 25 larvae per batch) in 1 day. Hence, 3 additional experiment days will enable 6 treatments to be tested at the required level of statistical precision. This is considered to be worthwhile, because 6 treatments enables to test critical sound exposure levels for which the first 3 trials were inconclusive.

Proposal additional trials

Additional experiments are proposed, which focus on testing statistical significance of limited number of exposures. The goal is to attain certainty about the (absence of) effects observed in the first 3 trials. The available budget allows a maximum of 3 experiment days. The power analyses indicate 15 replicates per treatment are required. This enables a total of 6 treatments.

In principle the 6 treatments should include the control groups. The methodological correct way to treat a control group is to apply exactly the same procedure as in the exposure groups. Two control groups were included in each of the first 3 trials: control group 1 received exactly the same treatment as the exposure groups; control group 2 received almost the same treatment, but was not inserted into and

retrieved from the test chamber. Despite the extra handling, mortality was the same or lower in control group 1 compared to control group 2. The procedure of placing larvae into the test chamber is time consuming and hence determines the number of experiments that can be done in a day. It is proposed to skip this procedure for the control groups, i.e. use only 1 control group which is not inserted in the test chamber in each additional trial. This enables the 6 treatments to be used for 6 exposures.

The exposures will be limited to pressure-excitation exposures, because the previous trials indicate that this may affect survival. There are no indications that velocity-excitation exposures may affect survival.

All experiments will be carried out without overpressure (simulating a water depth of 0m), because the previous trials were carried out with 0 - 0.5 bar overpressure. Furthermore, the greatest effect of sound pressure is expected to occur at a low static pressure.

It is proposed to use 1 experiment day for each larval stage. Insight in differences between larval stages in their response to sound is necessary to be able to evaluate the effect of sound at the population level. The previous trials indicated differences between the larval stages which were unexpected. The largest effects were expected in the stage 3, because in this stage the swimming bladder is maximally inflated, but the largest effects were observed in stage 2.

For each larval stage (stage 1-3), 2 exposures and 1 control treatment will be carried out (15 replicates, 25 larvae per batch). The following 2 exposures are proposed for each larval stage:

1. SEL = 207 dB, peak-pressure = 211 dB (corresponding to 100m and 100 strokes)
2. SEL = 202 dB, peak-pressure = 206 dB (corresponding to 200m and 100 strokes)

The first exposure is the highest sound pressure exposure that is possible with the experimental set-up. This exposure is 24 dB above the US Caltrans Fisheries Hydro-acoustic Working Group norm for non-auditory tissue damage in small fish. The second exposure is 5 dB lower than the first exposure in both SEL and peak pressure.

The expected result is no significant effects for either exposure in any larval stage. This expectation is based on the fact that no effects were observed in trial 3 (stage 3) at the highest exposure level, while the greatest effect was expected for this larval stage. If true, then the threshold for a 50% effect is at a distance <100m from a typical North Sea pile driving site. If the effect of the first exposure is significant but the effect of the second exposure is not then the threshold for a 50% effect is at a distance between 100 and 200m from a typical North Sea pile driving site. Based on the results in the first 3 trials, it is considered to be highly unlikely that the effects of both exposures are significant in any larval stage.

The duration of monitoring was 10-12 days in the first 3 trials. This will be reduced in the additional trials because it is impossible to monitor 3 trials (with 45 experiments per trial) for 10 days, given the available budget. Reducing the monitoring period is preferred above reducing the number of treatments or replicates. Based on the results of the previous trials it is expected that if an effect occurs, it is observed after 5 days. Therefore the batches will be monitored at least 5 days. Pragmatic advantage of a 5-day monitoring period is that all larval stages can be obtained from 1 spawning event in combination with the fact that monitoring of one trial is finished before the next trial starts. Possibilities for extending the monitoring period to 7 days will be examined.

References

Bolle et al. (2010). Shortlist Masterplan Wind. Effect of piling noise on the survival of fish larvae (pilot study). Progress report December 2010. IMARES report C176/10.

Details statistical power analyses

Trial 1

T=5

THE POSTULATED TREATMENT EFFECT and DEATH RATE IS HIGHER THAN OBSERVED IN THE TRIAL EXPERIMENT: THE RATIO OF TREATMENT TO CONTROL DEATH RATES IS HIGH WHICH MEANS THAT THE POWER OF DETECTING A TREATMENT EFFECT IS ALSO ESTIMATED TO BE HIGH. IN THE TRIAL EXPERIMENT DEATH RATES WERE LOW AND NO CONTAINER EFFECT WAS APPARENT. GIVEN THE POSTULATED HIGHER DEAT RATES IT WOULD BE CONSERVATIVE TO ASSUME A CONTAINER EFFECT SIMILAR IN MAGNITUDE TO THAT OBSERVED AT T=10. THEREFORE< WE HAVE USED A CONTAINER EFFECT VARIANCE OF 0.8.

Power (estimated expected % success) of **detecting significant difference (at 95% level) between death rates of treatment and control** for 25 or 50 larvae per batch, and for 5,10,15,20, or 30 replicates per treatment. The power is computed for a **control with a death rate of 0.3**, and a **treatment with a death rate of 0.65**. The variance of the container effect is 0.8.

	25	50
5	47	50
10	89	90
15	96	97
20	100	100
30	100	100

Power (estimated expected % success) of **estimating a treatment to control ratio of death rates which is significantly smaller (at 95% level) than 0.65/0.3=2.17** for 25 or 50 larvae per batch, and for 5,10,15,20, or 30 replicates per treatment. The power is computed for a **control with a death rate of 0.3**, and a **treatment with a death rate of 0.37**. The variance of the container effect is 0.8.

	25	50
5	36	37
10	63	70
15	78	82
20	86	89
30	94	96

Trial 1**T=10**

THE POSTULATED TREATMENT EFFECT and DEATH RATE ARE SIMILAR TO THAT OBSERVED IN THE TRIAL EXPERIMENT. THE ESTIMATED CONTAINER EFFECT VARIANCE IS USED IN THE POWER ANALYSIS.

Power (estimated expected % success) of **detecting significant difference (at 95% level) between death rates of treatment and control** for 25 or 50 larvae per batch, and for 5,10,15,20, or 30 replicates per treatment. The power is computed for a **control with a death rate of 0.7**, and a **treatment with a death rate of 0.85**. The variance of the container effect is 1.82.

	25	50
5	8	10
10	24	25
15	35	38
20	41	45
30	60	63

Power (estimated expected % success) of estimating a treatment to control **ratio of death rates which is significantly smaller (at 95% level) than $0.85/0.7=1.21$** for 25 or 50 larvae per batch, and for 5,10,15,20, or 30 replicates per treatment. The power is computed for a **control with a death rate of 0.7**, and a **treatment with a death rate of 0.73**. The variance of the container effect is 1.82.

	25	50
5	24	26
10	33	25
15	35	39
20	48	45
30	50	58

Trial 2**T=5**

THE POSTULATED TREATMENT EFFECT and DEATH RATE ARE SIMILAR TO THAT OBSERVED IN THE TRIAL EXPERIMENT. THE ESTIMATED CONTAINER EFFECT VARIANCE IS USED IN THE POWER ANALYSIS.

Power (estimated expected % success) of **detecting significant difference (at 95% level) between death rates of treatment and control** for 25 or 50 larvae per batch, and for 5,10,15,20, or 30 replicates per treatment. The power is computed for a **control with a death rate of 0.5**, and a **treatment with a death rate of 0.75**. The variance of the container effect is 0.4.

	25	50
5	44	49
10	84	87
15	97	98
20	99	100
30	99	100

Power (estimated expected % success) of **estimating a treatment to control ratio of death rates which is significantly smaller (at 95% level) than $0.75/0.5=1.5$** for 25 or 50 larvae per batch, and for 5,10,15,20, or 30 replicates per treatment. The power is computed for a **control with a death rate of 0.5**, and a **treatment with a death rate of 0.55**. The variance of the container effect is 0.4.

	25	50
5	35	44
10	65	68
15	76	84
20	91	94
30	95	98

Trial 2**T=10**

THE POSTULATED TREATMENT EFFECT and DEATH RATE ARE SIMILAR TO THAT OBSERVED IN THE TRIAL EXPERIMENT. THE ESTIMATED CONTAINER EFFECT VARIANCE IS USED IN THE POWER ANALYSIS.

Power (estimated expected % success) of **detecting significant difference (at 95% level) between death rates of treatment and control** for 25 or 50 larvae per batch, and for 5,10,15,20, or 30 replicates per treatment. The power is computed for a **control with a death rate of 0.6**, and a **treatment with a death rate of 0.8**. The variance of the container effect is 0.8398.

	25	50
5	21	23
10	46	54
15	72	73
20	85	88
30	95	97

Power (estimated expected % success) of **estimating a treatment to control ratio of death rates which is significantly smaller (at 95% level) than $0.8/0.6=1.33$** for 25 or 50 larvae per batch, and for 5,10,15,20, or 30 replicates per treatment. The power is computed for a **control with a death rate of 0.6**, and a **treatment with a death rate of 0.7**. The variance of the container effect is 0.8398.

	25	50
5	21	22
10	29	30
15	33	35
20	40	44
30	51	52

Trial 3

T=10

THE POSTULATED TREATMENT EFFECT and DEATH RATE IS HIGHER THAN OBSERVED IN THE TRIAL EXPERIMENT: THE RATIO OF TREATMENT TO CONTROL DEATH RATES IS HIGH WHICH MEANS THAT THE POWER OF DETECTING A TREATMENT EFFECT IS ALSO ESTIMATED TO BE HIGH. IN THE TRIAL EXPERIMENT DEATH RATES WERE LOW AND NO CONTAINER EFFECT WAS APPARENT. GIVEN THE POSTULATED HIGHER DEAT RATES IT WOULD BE CONSERVATIVE TO ASSUME A CONTAINER EFFECT SIMILAR IN MAGNITUDE TO THAT OBSERVED AT T=10. THEREFORE< WE HAVE USED A CONTAINER EFFECT VARIANCE OF 0.8.

Power (estimated expected % success) of **detecting significant difference (at 95% level) between death rates of treatment and control** for 25 or 50 larvae per batch, and for 5,10,15,20, or 30 replicates per treatment. The power is computed for a **control with a death rate of 0.2**, and a **treatment with a death rate of 0.6**. The variance of the container effect is 0.8.

	25	50
5	60	67
10	96	97
15	100	100
20	100	100
30	100	100

Power (estimated expected % success) of **estimating a treatment to control ratio of death rates which is significantly smaller (at 95% level) than 0.6/0.2=3** for 25 or 50 larvae per batch, and for 5,10,15,20, or 30 replicates per treatment. The power is computed for a **control with a death rate of 0.2**, and a **treatment with a death rate of 0.28**. The variance of the container effect is 0.8.

	25	50
5	43	47
10	73	74
15	85	88
20	94	96
30	98	99